



# PRODUCT CATALOGUE

[WWW.CADDYSTORAGE.COM.AU](http://WWW.CADDYSTORAGE.COM.AU)

ISSUE 7

CBR011B

**CADDY**  
STORAGE

For all your vehicle storage solutions!



CADDY

CADDY

CADDY



## WHO ARE WE?

Caddy storage is a family owned, Australian manufacturing company. Our services include design, fabrication and distribution of vehicle storage systems and accessories, we cater to the Australian automotive industry. Our mission is to provide well-organised, affordable and practical storage solutions and accessories for any vehicle in any trade. No job is too big or too small - we cater to everyone, from sole traders to corporate businesses to national fleet companies.

Established in 1986, the company started out in the family garage at Northmead, Sydney. Since then we have grown to become one of Australia's largest manufacturers and suppliers of commercial vehicle storage systems and automotive accessories. Today, Caddy Storage has expanded to 8 Company Branches and 3 Affiliated Stores which has created over 150 jobs in this niche market. Each of our locations boast its own showroom and fitting stations.

The initial purpose of Caddy Storage was to manufacture and install shelving systems only. However, with the demand for tradespeople to have a well-organised work vehicle with maximum cargo space, it soon became apparent that many customers had requirements for additional trade accessories and so the company progressed to the development for a series of new products including rear steps, towbars, cargo barriers, drawer systems and most recently, aluminium canopies.

Through consistent acquisition of state-of-the-art machinery in our manufacturing plant and the newest 3D technology to design our products, we ensure that our goods are of the highest quality and visually appealing. With our equipment, we have the ability to produce fully customised solutions for a range of trades. New projects are constantly in development at Caddy Storage and our current position ensures that in the years ahead, we will continue to strive to provide a wide range of quality products, competitively priced with excellent customer service.

## WHY CHOOSE CADDY?

At Caddy Storage, we pride ourselves on our exclusive ability to manufacture most of our product in-house at our Sydney headquarters, giving us the advantage to customise to your specific requirements.

We have an expert team in the automotive field who will ensure the best possible outcome for your storage problems. Whether it's something as simple as providing you with a few accessories for your business, or transforming your vehicle with a fit out that caters to your exact needs, Caddy storage can deliver to your expectation.

Our Sydney headquarters is equipped with top of the range computerised design and manufacturing devices consisting of CNC tube benders, CNC bending machines, CNC turret punches, laser cutter, robotic press brake, hi tech welding bays, powder coating bays and much more. We invest heavily in world class equipment to ensure we can still proudly manufacture in Australia.

Our experienced sales team can assess your vehicle and recommend the most appropriate products and / or accessories to help make your fleet or business vehicle as easy to use and convenient as possible. Then, our in-house design and engineering team can assist in developing a solution that's right for you and your business, from the initial concept through the design and production process all the way to installation, all in the one location.



**1986** Caddy Storage founded for manufacturing shelving systems.

**1988** First factory built for offices, production, fitting and despatch.

**1990** Galvanised Van Rear Step development.



**2000** First Interstate store established in Tullamarine, VIC

**2003** New Integrated Shelving Unit design and production.

**2004** First established business in Rocklea, QLD



## 1980 - 1999

## 2000 - 2009



**1993** Ausguard Cargo Barriers and Caddy Slides begin production.

**1996** Factory expanded to neighbouring building.

**1998** Initial Drawer and Integrated shelving development.



**2006** Ute Canopies introduced. New Caddy Drawer Manufacturing commences.

**2007** First established business in Canning Vale, WA. Towbar development commences.

**2008** Adjustable shelving design development and implementation.





**2010** Head Office moves to a larger premises in Blacktown, NSW.

**2010** Rocklea store move to a larger premises in Parkinson, QLD.

**2012** Aluminium Canopy Design and Production.



**2014** Perth moves to larger premises in Canning Vale. Second Melbourne store opens in Braeside, VIC.



**2019** New range of Aluminium Canopies introduced. Toolboxes added to product range.

**2020** Second Melbourne store moves to a larger premises in Braeside, VIC.

**2020** Partnership with Hayman Reese Towbars announced.



## 2010 - 2018

**2013** Upgrade of manufacturing facility with new technology.



**2016** First established Affiliate store in Nailsworth, SA.

**2017** Second Store in Prestons, NSW. Third store in Tuggerah, NSW opens.

**2018** Second Brisbane store opens in Brendale, VIC.



**2021** Two new NSW Affiliate Stores added to Caddy Network in Taren Point, NSW and Parramatta, NSW.



**2022** Third QLD store opens in Burleigh heads, Gold Coast.

**2022** Third Affiliate store opens in Wollongong, NSW.

**2022** New Range of Drawers Introduced. Single and Dual Direction opening Drawers offered.

**2023** New Store opens in Beresfield, NSW







# CONTENTS PAGE

## VEHICLE SHELVING

Standard Van Kits .....	08
Large Van Kits.....	09
Extra Large Van Kits .....	10
Ute Kits .....	11
Aluminium Canopy Kits .....	12

### Additional Information

Shelving Customisations .....	14
End Panels .....	15

## SHELVING ACCESSORIES

Shelving Accessories .....	16 - 17
----------------------------	---------

## CARGO BARRIERS

Cargo Barriers .....	18 - 19
Air Curtains & Conversion Kits .....	20

## REAR STEPS

Rear Step Features and Options .....	22 - 23
--------------------------------------	---------

## UTE CANOPIES

Lifestyle Canopies .....	24
Workstyle Canopies.....	25

## ALLOY CANOPIES / TOOLBOXES

Aluminium Canopies and Accessories .....	26 - 27
Toolboxes and Accessories .....	28 - 29

## SMALL PARTS STORAGE

Caddy Parts Storage (CPS) Drawer .....	30 - 31
Plastic Bins .....	33

## DRAWERS AND SLIDES

Heavy Duty Drawers .....	34 - 35
Flat Top Slides .....	36 - 37

## WALL PANNELLING / FLOORING

Wall Panneling Options .....	38
Flooring Options .....	39
False Flooring .....	40

## WINDOWS / WINDOW GUARDS

Window Guards .....	42
Windows .....	43

## OTHER ACCESSORIES

### Auto Electrical

Lighting .....	44
Reversing Systems .....	45
Power Supply .....	46

### Health and Safety

Hygiene Unit, First Aid and Fire Extinguisher .....	47
---	----

### Trade Accessories

Trade Accessories .....	48 - 49
-------------------------	---------

## INDUSTRY SPECIFIC FIT OUTS

Industry Specific Fit Outs .....	50 - 57
----------------------------------	---------

## PARTNERS / SUPPLIERS

Rhino Rack Roof Rack Systems .....	58 - 59
Tradesman Roof Rack Systems .....	60
Techsafe Seating .....	61
Hayman Reese Towbars.....	62 - 63
East Coast Bullbars Front / Nudge Bars .....	64 - 65

# STANDARD VAN KITS

## Suitable for Small and Medium sized vans

Standard Van Kits are our specialty and our most popular shelves. We have been developing shelving systems for over 20 years and our premium adjustable shelving range will guarantee longevity and convenience.

### Features:

- Standard or full side panels available
- 4 -5 adjustable shelves

### Specifications:

- Unit widths: 850mm or 1080mm or 1260mm
- Unit heights: 1170mm or 1220mm or 1290mm

Suits most Panel and Commercial Vans such as Ford, Hyundai, LDV, Mercedes, Mitsubishi, Renault, Toyota, Volkswagen and more.

For more information and to see our full range of Standard Van Kits available visit [www.caddystorage.com.au/product-category/standard-shelving-kits/standard-van-kits](http://www.caddystorage.com.au/product-category/standard-shelving-kits/standard-van-kits)



Scan QR code to view the page on our website



## SHELVING WIDTHS AVAILABLE



### ADJ01-A

**Dimensions: 850mm W x 1220mm H x 420mm D**

ADJ01-A shelving unit comes with 4 rows of adjustable shelving (5 rows with full end panels). The top shelf is 310mm deep and the lower shelves are 410mm deep. This shelving unit can fit up to 8 small plastic bins or 4 large plastic bins per row.

Additional shelving accessories sold separately.



### ADJ01-B

**Dimensions: 1080mm W x 1220mm H x 420mm D**

ADJ01-B shelving unit comes with 4 rows of adjustable shelving (5 rows with full end panels). The top shelf is 310mm deep and the lower shelves are 410mm deep. This shelving unit can fit up to 10 small plastic bins or 5 large plastic bins per row.

Additional shelving accessories sold separately.



### ADJ01-C

**Dimensions: 1260mm W x 1220mm H x 420mm D**

ADJ01-C shelving unit comes with 4 rows of adjustable shelving (5 rows with full end panels). The top shelf is 310mm deep and the lower shelves are 410mm deep. This shelving unit can fit up to 12 small plastic bins or 6 large plastic bins per row.

Additional shelving accessories sold separately.



# LARGE VAN KITS

## Suitable for Large Vans

Large van shelving kits take full advantage of the raised roof and maximise floor to roof space for more storage options. These kits provide a greater ability for customization as shelving can be removed to carry larger items if required.

### Features:

- Standard or full side panels available
- 6 -8 adjustable shelves

### Specifications:

- Unit widths: 850mm or 1080mm or 1260mm
- Unit Heights: 1490mm or 1570mm or 1760mm

Suits Low to Medium Roof and some High Roof Commercial Vans such as Fiat, Ford, LDV, Mercedes, Renault, Toyota, Volkswagen and more.

For more information and to see our full range of Large Van Kits visit [www.caddystorage.com.au/product-category/standard-shelving-kits/standard-van-kits](http://www.caddystorage.com.au/product-category/standard-shelving-kits/standard-van-kits)



Scan QR code to view the page on our website

CARGO  
BARRIERS

REAR STEPS

UTE CANOPIES

ALLOY CANOPY /  
TOOL BOXESSMALL PARTS  
STORAGEDRAWERS AND  
SLIDESWALL PANELLING/  
FLOORINGWINDOW /  
WINDOW GUARDSOTHER  
ACCESSORIESINDUSTRY  
SPECIFIC FIT OUTSPARTNER /  
SUPPLIERS

## SHELVING WIDTHS AVAILABLE



### ADJ75-U

**Dimensions: 850mm W x 1490mm H x 420mm D**

ADJ75-U shelving unit comes with 6 rows of shelving (7 rows with full end panels). The top 2 shelves are 310mm deep and the lower shelves are 410mm deep. This shelving unit can fit up to 8 small plastic bins or 4 large plastic bins per row.

Additional shelving accessories sold separately.



### ADJ75-V

**Dimensions: 1080mm W x 1490mm H x 420mm D**

ADJ75-V shelving unit comes with 6 rows of shelving (7 rows with full end panels). The top 2 shelves are 310mm deep and the lower shelves are 410mm deep. This shelving unit can fit up to 10 small plastic bins or 5 large plastic bins per row.

Additional shelving accessories sold separately.



### ADJ75-W

**Dimensions: 1260mm W x 1490mm H x 420mm D**

ADJ75-W shelving unit comes with 6 rows of shelving (7 rows with full end panels). The top 2 shelves are 310mm deep and the lower shelves are 410mm deep. This shelving unit can fit up to 12 small plastic bins or 6 large plastic bins per row.

Additional shelving accessories sold separately.

# EXTRA LARGE VAN KITS

## Suitable for Extra Large or Jumbo Vans with High Roof

Size does matter with our extra large van kits. Towering at almost 2 metres in height, these shelving units can store everything. We have reinforced our end panels with additional framing to provide stability to the unit. These kits provide a greater ability for customization as shelving can be removed to carry larger items if required.

### Features:

- Heavy duty end panels
- 7 Adjustable shelves

### Specifications:

- Unit widths: 850mm or 1080mm or 1260mm
- Unit Height: 1950mm

Suits High and Super High roof Commercial vans such as Fiat, Mercedes and Volkswagen.

For more information and to see our full range of Extra Large Van Kits visit [www.caddystorage.com.au/product-category/standard-shelving-kits/large-van-kits](http://www.caddystorage.com.au/product-category/standard-shelving-kits/large-van-kits)



Scan QR code to view the page on our website



## SHELVING WIDTHS AVAILABLE



### K15-FA7-850/1950

**Dimensions: 850mm W x 1950mm H x 435mm D**

K15-FA7-850/1950 shelving unit comes with 7 rows of shelving. The top shelf is 240mm deep, 2nd row is 310mm deep and the lower shelves are 410mm deep. This shelving unit can fit up to 8 small plastic bins or 4 large plastic bins per row.

Additional shelving accessories sold separately.



### K15-FA7-1080/1950

**Dimensions: 1080mm W x 1950mm H x 435mm D**

K15-FA7-1080/1950 shelving unit comes with 7 rows of shelving. The top shelf is 240mm deep, 2nd row is 310mm deep and the lower shelves are 410mm deep. This shelving unit can fit up to 10 small plastic bins or 5 large plastic bins per row.

Additional shelving accessories sold separately.



### K15-FA7-1260/1950

**Dimensions: 1260mm W x 1950mm H x 435mm D**

K15-FA7-1260/1950 shelving unit comes with 7 rows of shelving. The top shelf is 240mm deep, 2nd row is 310mm deep and the lower shelves are 410mm deep. This shelving unit can fit up to 12 small plastic bins or 6 large plastic bins per row.

Additional shelving accessories sold separately.

# UTE KITS

## Suitable for vehicles with Canopy Installed

Ute shelving kits serve as a companion piece to a canopy and drawer combination. The shelving unit is well suited to sit upon a drawer system within a ute tub. It is perfect when combined with a ute canopy as you can access the shelving unit through the side lift up doors. This is good for tradesmen who want to quickly access their spare parts without having to completely open their vehicle.

### Features:

- Integrated Shelving
- 3 Fixed Shelves

### Specifications:

- Unit widths: 850mm or 1080mm or 1260mm
- Unit height: 465mm
- Unit depths: 315mm or 415mm

Suits any ute with a canopy and drawer system installed.

For more information and to see our full range of Ute Kits available visit [www.caddystorage.com.au/product-category/standard-shelving-kits/ute-kits](http://www.caddystorage.com.au/product-category/standard-shelving-kits/ute-kits)



Scan QR code to  
view the page on  
our website



## SHELVING WIDTHS AVAILABLE



### K22-SA-850/465

**Dimensions: 850mm W x 465mm H x 335mm D**

K22-SA-850/465 feature 3 fixed shelves. The top shelf is 230mm deep and the bottom two shelves are 300mm deep. This shelving unit can fit up to 8 small plastic bins or 4 large plastic bins per row. We can also produce a version with 400mm deep shelving for added space.

Plastic bins sold separately.



### K22-SA-1080/465

**Dimensions: 1080mm W x 465mm H x 335mm D**

K22-SA-1080/465 feature 3 fixed shelves. The top shelf is 230mm deep and the bottom two shelves are 300mm deep. This shelving unit can fit up to 10 small plastic bins or 5 large plastic bins per row. We can also produce a version with 400mm deep shelving for added space.

Plastic bins sold separately.



### K22-SA-1260/465

**Dimensions: 1260mm W x 465mm H x 335mm D**

K22-SA-1260/465 feature 3 fixed shelves. The top shelf is 230mm deep and the bottom two shelves are 300mm deep. This shelving unit can fit up to 12 small plastic bins or 6 large plastic bins per row. We can also produce a version with 400mm deep shelving for added space.

Plastic bins sold separately.

# ALUMINIUM CANOPY KITS

## Suitable for Vehicles fitted with a Tray top Aluminium Canopy

These kits are exclusive to Aluminium Canopies. Shelving accessories can be placed on the side and back panels of the shelving unit allowing for greater customisation. Have your choice of either 3 or 4 shelves for the 660mm high unit, and 4 or 5 shelves for the 800mm high unit. This modular shelving unit can be installed by itself, or as part of a set system which includes drawers, small parts drawers and frames. Bottom shelving rows can be modified with a lockable door and base frame.

### Features

- Unique design specific to Aluminium Canopies
- 3 - 5 fixed shelves
- Modular (shelving accessories sold separately)

### Specifications

- Unit widths: 850mm or 1080mm or 1260mm
- Unit Heights: 660mm or 800mm

Suits any ute with an installed Tray top Aluminium Canopy, however sizing and fitting are subject to the internal dimensions of the Aluminium Canopy.

For more information and to see our full range of available aluminium canopy shelving kits visit [www.caddystorage.com.au/product/standard-shelving-kits/aluminium-canopy-kit/shelving-aluminium-canopy](http://www.caddystorage.com.au/product/standard-shelving-kits/aluminium-canopy-kit/shelving-aluminium-canopy)



Scan QR code to view the page on our website



## SHELVING WIDTHS AVAILABLE



### SB-SHE-0850.0660-4-ASM

Dimensions: 850mm W x 660mm H x 420mm D

SB-SHE-0850.0660-4 comes with 3 or 4 rows of fixed shelving. Top row is 305mm deep, 2nd row is 350mm deep and bottom rows are 405mm deep. This shelving unit can fit up to 8 small plastic bins or 4 large plastic bins per row.

Additional accessories sold separately.



### SB-SHE-1080.0660-4-ASM

Dimensions: 1080mm W x 660mm H x 420mm D

SB-SHE-1080.0660-4 comes with 3 or 4 rows of fixed shelving. Top row is 305mm deep, 2nd row is 350mm deep and bottom rows are 405mm deep. This shelving unit can fit up to 10 small plastic bins or 5 large plastic bins per row.

Additional accessories sold separately.

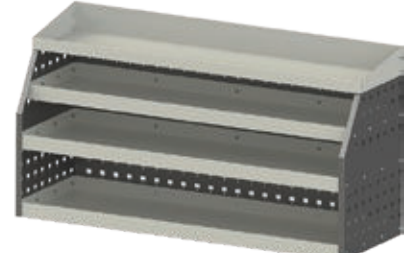

### SB-SHE-1260.0660-4-ASM

Dimensions: 1260mm W x 660mm H x 420mm D

SB-SHE-1260.0660-4 comes with 3 or 4 rows of fixed shelving. Top row is 305mm deep, 2nd row is 350mm deep and bottom rows are 405mm deep. This shelving unit can fit up to 12 small plastic bins or 6 large plastic bins per row.

Additional accessories sold separately.



CARGO  
BARRIERS

REAR STEPS

UTE CANOPIES

ALLOY CANOPY /  
TOOLBOXES

SMALL PARTS  
STORAGE

DRAWERS AND  
SLIDES

WALL PANELLING /  
FLOORING

WINDOW /  
WINDOW GUARDS

OTHER  
ACCESSORIES

INDUSTRY  
SPECIFIC FIT OUTS

PARTNER /  
SUPPLIERS

# SHELVING CUSTOMISATIONS

Not completely satisfied? At Caddy we have creative custom solutions to make fitting your shelving unit onto your vehicle.

**1. Custom Framework shelving.** We can measure and custom create a shelving unit for your setup. This is perfect for clients needing to store specialised tools and equipment.

**2. Reversed shelving.** Can assist in easy accessibility to your tools and gadgets. This is a superb option for vehicles with two sliding doors.

**3. Modified Legs.** To maximise storage efficiency we can remove the bottom legs from our base model shelving units, which allows the unit to be mounted on top of our drawer unit.

**4. Boxed Shelving unit.** We can custom create a shelving unit designed to be mounted horizontally or directly behind the cargo barrier. This shelving unit has more of a box like appearance due to the position it is placed in.

**5. Custom End Panels.** We can adjust shelving end panels to accommodate the shape of certain vehicles.



# SHELVING END PANELS

## CHOOSE YOUR STYLE

What a better way to organise your tools! Our diverse range of vehicle shelving is suitable for both vans and utes alike. All units are designed to maximise the space in your cargo area with room for customisation, and will maintain a stylish look for your work vehicle with our standard colour scheme.

In our adjustable shelving range you can choose from standard or full end panels. Shelves can be adjusted every 30mm from the bottom hole on the end panel to the top hole on the end panels.



**Standard End Panel.** Most practical and versatile option. Can be mounted in any position in the vehicle. Can be customised to your specific needs.



**Full End Panel.** The panels cover the sides from Top to Bottom. Cannot be installed when partially covering the wheel arches. Provides an additional row of shelving.

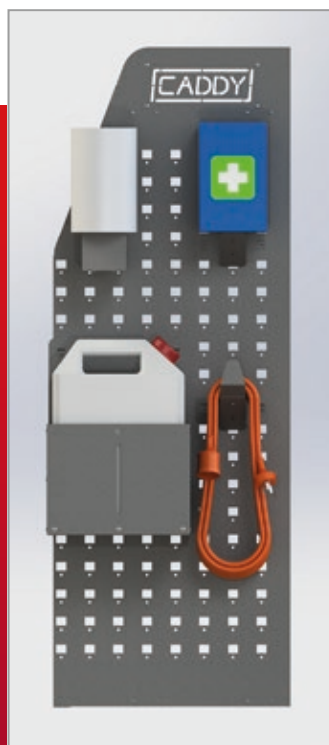
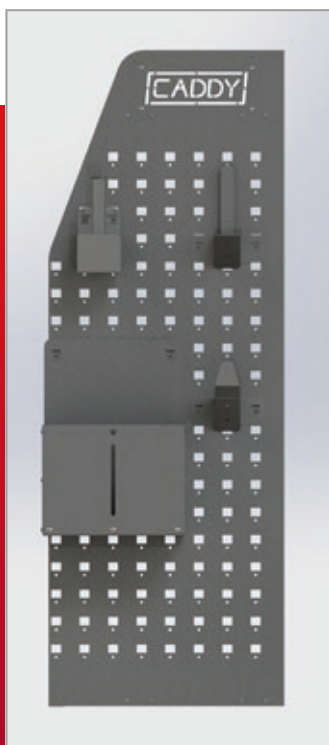

## SHELVING ACCESSORIES

Even the simplest additions to your internal fit out can make your day-to-day tasks a lot less complicated. Our aim is to provide you with practical storage solutions and our range of internal vehicle accessories to accompany your shelving will help maintain a well-organised working vehicle.

Remember the end panels we mentioned before? The punched holes on these panels can be utilised for hanging accessories that can be adjusted in any combination you desire. Pages 16 - 17 outlines some Shelving accessories compatible with our end panels.

# SHELVING ACCESSORIES

Even the simplest additions to your internal fit out can make day-to-day tasks a lot less complicated. Our aim is to provide you with practical storage solutions and our range of internal vehicle accessories to accompany your shelving will help maintain a well organised working vehicle. Our unique shelving end panel design is punched with holes that can be utilised for hanging accessories which can be adjusted in any combination you desire.

For more information and to see our full range of Shelving Accessories available visit [www.caddystorage.com.au/product-category/standard-shelving-kit-accessories/adjustable-shelving-unit-accessories](http://www.caddystorage.com.au/product-category/standard-shelving-kit-accessories/adjustable-shelving-unit-accessories)



Scan QR code to view the page on our website

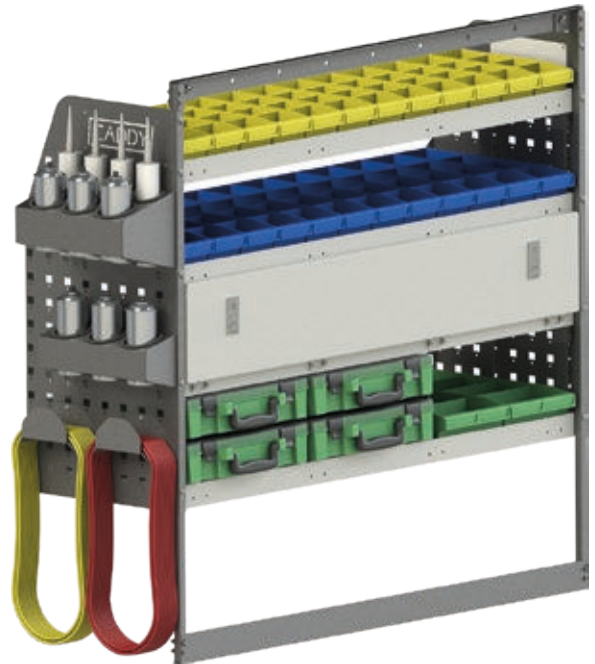

## Lockable doors

Lockable single or double doors to secure items, suitable for any shelf, excluding the top shelf on kits.



## Cable shelf

We remove the bottom two rows and replace it with a cable shelf. The shelf matches a cable reel shape, preventing unnecessary movement while travelling.

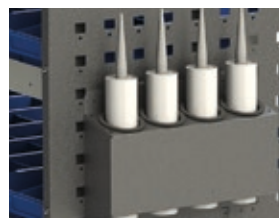

## Silicone Tube Holder

Silicone tube holders can be mounted onto any position on our shelving unit end panels. Can hold 4 or 8 silicone tubes.



## Spray Can holder

Spray can holders can be mounted onto any position on our shelving unit end panels. Optional version with 4 silicone tube holders available.

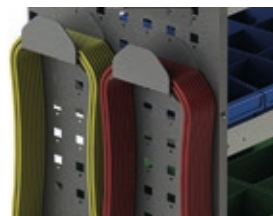

## Extension Lead Holder

Extension lead holders allow you to hang multiple sized leads from your shelving unit.



## Carry case holder

Single carry case frame positioned on shelving end panel, carry case included.



## Double Carry case holder

Double carry case frame positioned in shelving. Carry Cases included.





**Paper Towel Holder**

Paper towel holders can be mounted onto any position on our shelving unit end panels. Can be used to carry paper towels. Pairs well with a hand wash system.



**Carrying Hook**

Carrying hooks can be mounted onto any position on our shelving unit end panels. Can be used to carry small cables or similar items.



**Straps**

Various sizes of cam lock buckle and ratchet straps are available to secure your items.



**First Aid Kit Holder**

First Aid Kit holders can be mounted onto any position on our shelving unit end panels. Can hold a small first aid kit or similar.



**Water Bottle Holder**

This can be mounted onto any position on our shelving unit end panels. Can hold a 10 Litre water container. We can add a water laundry tap for easier use.



**Soap / Sunscreen Dispenser**

We can incorporate soap or sunscreen dispensers on the end of the shelving panel.

# CARGO BARRIERS

Caddy Storage specialises in all types of mesh, polycarbonate and vapour resistant cargo barrier to suit your needs, whether it's to stop items entering the cabin or to protect yourself from harmful gases or fumes.

Our large factory and warehouse ensures that we have products in stock, and our design and manufacturing department gives us the ability to develop cargo barriers for most of the new vehicles entering the market. Most of our cargo barriers are designed and tested to AS/NZS 4034.1 standards.

We have several different types and combinations of cargo barriers on offer for vans, utes, passenger vehicles and 4WDs. Available in front, dual or rear position, depending on your vehicle and your requirements.

For more information and to see our full range of cargo barriers available visit [www.caddystorage.com.au/product-category/vehicle-specific-accessories/cargo-barriers-and-air-curtains](http://www.caddystorage.com.au/product-category/vehicle-specific-accessories/cargo-barriers-and-air-curtains)



Scan QR code to view the page on our website

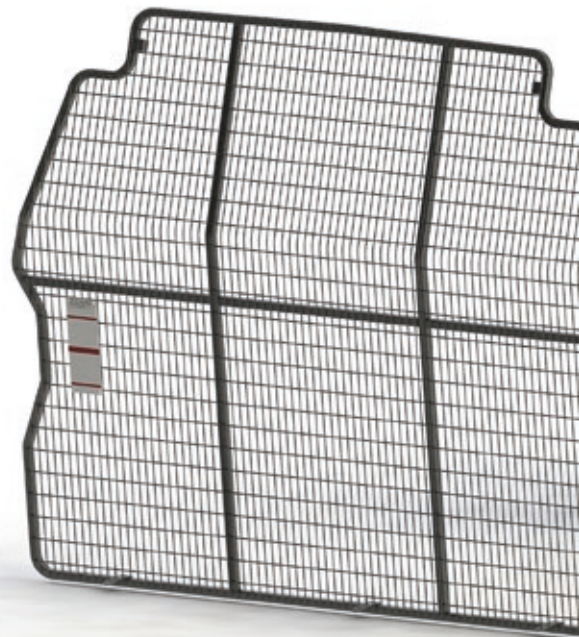

## MESH CARGO BARRIER

Suitable for Vans, Utes, SUVs, 4WDs and Hatchbacks.

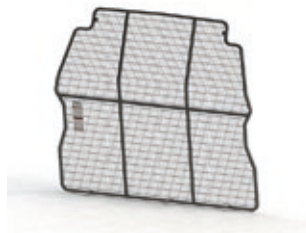

Our most commonly sought after product. It features a 25mm x 50mm mesh, welded onto a steel frame and powder coated graphite grey. We match our cargo barrier shape to the interior of the vehicle.

Depending on the vehicle, we can fit the barrier near the front, or towards the rear of the vehicle. Some of our barriers are dual position, meaning that with a few adjustments, can be moved from front to rear position at any time.

## MID POSITION MESH CARGO BARRIER

Suitable for most Small to Medium sized vans.

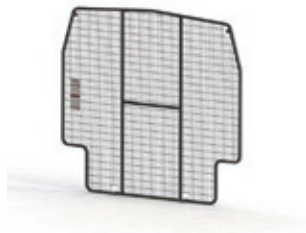

Can be installed at any position between the back of the side sliding doors to the rear door depending on your preferred position. It features a 25mm x 50mm mesh, welded onto a flat designed steel frame. This product normally acts as a divider between the rear seats and the

cargo area, but can also be used to segment different areas of the vehicle. To avoid intruding the wheel arches, we also supply a version with wheel arch cut outs, shaped to avoid any overlapping areas between the barrier and the wheel arches.

## MESH CARGO BARRIER WITH GAP

Suitable for Large and Extra-Large sized vans.

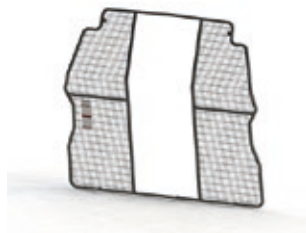

A good product for couriers or similar that require immediate access to their cargo area. We take our existing front position cargo barrier design and remove the entire mid column of the barrier. This creates a large gap for the user to go through. We can also manufacture a

sliding door for further safety. This product can be available in Mesh or as a Vapour resistant barrier.

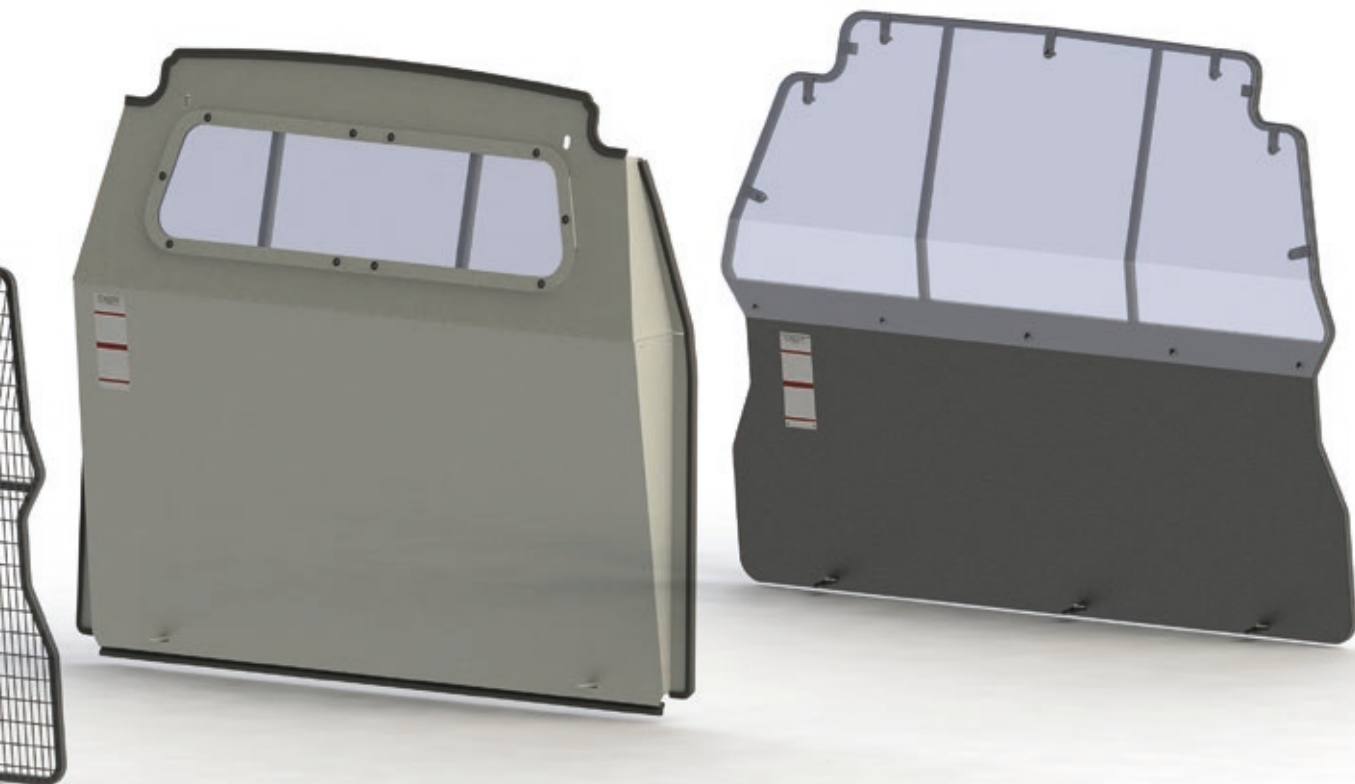

## VAPOUR RESISTANT CARGO BARRIER

Available across most van models.

Our range of vapour resistant cargo barriers are enclosed to limit gases and / or fumes travelling to the cabin of the vehicle. It features a large single piece of sheet metal reinforced with a metal frame. The edges are covered with a rubber pinch weld bubble seal which allows

the barrier to sit tightly in the vehicle. All of our vapour resistant cargo barriers are powder coated APO Grey and a majority are kinked with a large anti-glare window. This barrier helps protect as well as add some style to your cargo area.



## MID POSITION VAPOUR RESISTANT CARGO BARRIER

Available across most van models.

Can be installed at any position between the back of the side sliding doors to the rear door depending on your preferred position. It features a singular metal sheet with window, sealed with a rubber pinch weld. This product normally acts as a divider between the rear

seats and the cargo area, but can also be used to segment different areas of the vehicle. To avoid intruding the wheel arches, we also supply a version with wheel arch cut outs, shaped to avoid any overlapping areas between the barrier and the wheel arches.

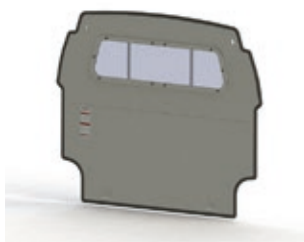

## POLYCARBONATE CARGO BARRIER

An uncommon product with a clear view.

A niche alternative to our Mesh Cargo Barriers. It features a tough polycarbonate top half with a reinforced sheet metal bottom half installed onto a welded steel frame. This barrier enhances the effect of air conditioning (foregoing the need for an air curtain) and has a

clearer rear vision than common mesh barriers. This product can only be installed in the front position (directly behind 1st row of seats) and is mostly used for small to medium sized vans and small SUVs.

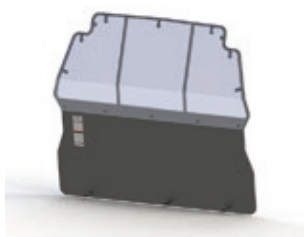

# AIR CURTAINS

## Available across most Caddy made Mesh Cargo Barrier Types

Air curtains can be developed for the cargo barrier to enhance the effectiveness of air conditioning and reduce noise from the cargo area of the vehicle. They attach to an installed Mesh Cargo Barrier and are custom made to suit different manufacturers profiles.

They are constructed from a lightweight clear PVC, with a strong and durable webbing sewn around the edges. Air curtains can easily be attached to the Cargo Barrier with electrical cable ties.

We also develop air curtains for genuine mesh cargo barriers.

For more information and to see our full range of air curtains available visit [www.caddystorage.com.au/product-category/vehicle-specific-accessories/cargo-barriers-and-air-curtains](http://www.caddystorage.com.au/product-category/vehicle-specific-accessories/cargo-barriers-and-air-curtains)



Scan QR code to view the page on our website



# CONVERSION KITS

## Suitable for Small Hatchbacks and SUVs

Achievable with a number of hatch vehicles, floor conversions give you a maximum space in your cargo area.

Conversions are done by folding down or removing the rear seats, installing a cargo barrier and a false formply floor with a carpet or rubber top. An engineering certificate may be required.

For more information and to see our full range of conversion kits available visit [www.caddystorage.com.au/product-category/vehicle-specific-accessories/conversions-kits](http://www.caddystorage.com.au/product-category/vehicle-specific-accessories/conversions-kits)



Scan QR code to view the page on our website





# CADDY REAR STEPS

Caddy Storage has been manufacturing and supplying rear steps since 1990. We have used over 30 years of experience and research to bring you our latest version of Caddy Storage made Rear Steps. Our Caddy Storage Rear Steps are competitively more affordable than most providers whilst maintaining the high quality that Caddy strives for.

Recently, we have partnered with Hayman Reese Towbars, a well known towbar / towball supplier and manufacturer in their respective industry. Their towbar technology plus our high quality rearsteps produce one of the best products out there in the market. We can guarantee that when you purchase with Caddy, you purchase quality.

For more information and to see our full range of available rearsteps and towbars, please visit [www.caddystorage.com.au/product-category/vehicle-specific-accessories/rear-protection-step-towbar](http://www.caddystorage.com.au/product-category/vehicle-specific-accessories/rear-protection-step-towbar)



Scan QR code to  
view the page on  
our website



## FEATURES



### Increased Rear Protection

Unlike competitors, our Rearsteps are designed to protect a very large majority of your rear bumper. Wider sides, thicker step bases and the use of slip resistant materials all help to keep your safety in check.



### Sensor Installation or Relocation

We supply new sensors which can be mounted onto our Rear Steps. We can also relocate existing vehicle sensors and move them to the rear steps.



### Caddy Rearstep Design

Our Rearstep design includes a much better integration with the towbar, dedicated slots for sensors (OEM and new) and sensor mounting blocks.



### Grab Handles

Handles installed adjacent to any rear or side lift up door. Provides a safe point of contact when reaching the roof area of your vehicle. These are good complimentary products for Rearsteps / Towbars.



### Accessible Roof Area

Our rear step provides a stable platform for you to use to access the roof racks from the rear of your vehicle.



### Hayman Reese Towbars

We supply and install Rearsteps incorporated with Hayman Reese Towbars and Tow balls. For more information please see Partners / Suppliers Section or page 60.



## OPTIONS AVAILABLE



### Black or Stainless Steel Loop Rearstep

Available in Black or Stainless Steel Side Loops. Checkerplate Steel Rear Step with two side loops for added protection. The rear step is a great tool for providing extra protection to your vehicle bumper as well as allowing you to effortlessly reach the roof of your vehicle. Grab Handles at an additional cost will assist in utilising the step.



### Cowhorn (Light Protection) Rearstep

Available with Black side "Cowhorn" Light Protection bars. Checkerplate Steel Rear Step with two side bars for light protection. The rear step with towbar is a great tool for providing light protection to your vehicle bumper as well as allowing you to effortlessly reach the roof of your vehicle. Grab Handles at an additional cost will assist in utilising the step



### Galvanised Rearstep

Galvanised steps are constructed from laser cut steel which is bent via computer numerical controlled (CNC) machinery. The frame-like design provides multi-layered protection from rear collisions and the blunt serrated tread step allows for additional grip when accessing the roof of your vehicle. The final welded raw steel step is chemically treated and hot galvanised dipped to be resistant to the harsh Australian weather. Our steps have a range of features including red reflectors on passenger and driver side, with the ability to house the vehicles OEM reverse sensors (Dependent on model).

# UTE CANOPIES

Caddy Storage is the Australian importer and distributor of Alpha Ute Canopies. Our canopies consist of a high quality hand-laid fibreglass one piece shell with a smooth finish, colour coded to the vehicle and includes several features such as a standard internal vinyl or carpeted lining, high mount brake light and tinted glass, our canopies are amongst the most stylish and durable on the market. Features include:

- Hand-laid fibreglass one piece shell for added strength
- Smooth finish
- Automotive paint
- Tempered safety glass
- Internal light with rear door activation
- Rear mounted 3rd brake light
- Slam latch door for single hand operation
- Reinforced fibreglass back door frame for increased strength & protection of glass
- Stainless steel hardware to prevent rust
- Lateral rear door water drain gutters to minimise water entering the tub
- Tinting manufactured into the side & rear glass windows for extra privacy
- Twin gas struts on all doors for easy opening and access
- Front sliding window for ease in cleaning the rear of the cabin window
- All canopies are uniquely keyed to avoid someone else having a matching key
- Design styling to complement the vehicle



Scan QR code to view the page on our website

For more information and to see our full range of Ute canopies, visit [www.caddystorage.com.au/product-category/ute-canoopies](http://www.caddystorage.com.au/product-category/ute-canoopies)



## LIFESTYLE CANOPIES

Lifestyle Ute canopies are perfect for everyday use - the roof height of the canopy sits flush with the height of the cabin, giving your vehicle a sporty look. All lifestyle canopies have internal vinyl roof lining and rear spoilers.

- Side sliding windows or lift up windows
- Factory fitted longitudinal rails
- Roof height level with cabin
- Internal vinyl roof lining
- Rear spoiler
- Remote locking on rear door

Also available:  
GTE/M1 Canopy (limited stock). Ask us in store about availability.



### GSE-S Lifestyle Canopy

This canopy has side sliding windows; both the front end and the rear end of the window slide open, providing some accessibility into the cargo area. Rear door central locking included as standard.



### GSS Lifestyle Canopy

This canopy has side sliding windows; both the front end and the rear end of the window slide open, providing some accessibility into the cargo area. Rear door central locking included as standard.



### GSE-L Lifestyle Canopy

This canopy has side lift up windows, giving you large side accessibility. Incorporates twin gas struts and slam latch doors for easy operation.



### GSX Lifestyle Canopy

This canopy has side lift up windows, giving you large side accessibility. Incorporates twin gas struts and slam latch doors for easy operation. Comes with remote 3 door central locking as standard.





## WORKSTYLE CANOPIES

Workstyle Ute canopies are the most suitable for tradesmen - the higher raised roof makes room for extra cargo to be stored. All workstyle canopies have internal carpet roof lining and twin gas struts on all doors.

- Side lift up panel doors or windows
- Large side accessibility
- Factory fitted tracks for fitting roof racks
- Added roof height for extra load capacity
- Internal carpet roof lining
- Remote locking on all 3 doors



### CME Workstyle Canopy

This canopy has side lift up doors for quick and easy accessibility via the large opening. The panel doors limit visibility into the cargo area.



### CMX Workstyle Canopy

This canopy has side lift up doors for quick and easy accessibility via the large opening. The panel door limit visibility into the cargo area. Comes with remote 3 door central locking as standard.



### CME-W Workstyle Canopy

This canopy is very similar in physical form to the CME canopy, with side lift up windows for added finesse.



### CMX-W Workstyle Canopy

This canopy is very similar in physical form to the CMX canopy, with side lift up windows for added finesse. Comes with 3 door central locking as standard.

# ALUMINIUM CANOPY (TRAY TOP)

Caddy Aluminium Canopies are a smart and economical choice for the travelling tradesmen, combining the storage capabilities of a van with the portability of a Ute. Our aluminium canopies are made to suit dual, extra and single cab utes. It features a 2.5mm flat aluminium plate body, reinforced with an interior steel framing, 2 gull wing side lift up doors and a rear lift up door. Lifting up the side and rear doors gives you on-site cover while you work and will shield you throughout most weather conditions.

Our Caddy Aluminium Canopies are one of the most modular products we have available. You can select from 3 different types of body finishes available: White powdercoat, Black powdercoat or Aluminium Propeller Plate.

We offer a large range of products to make your aluminium canopy specific to you. Anything from shelving units to lighting and roof racks - we take our time customising your aluminium canopy to how you like it.

For more information and to see our full range of available aluminium canopy, please visit [www.caddystorage.com.au/product-category/cab-chassis/aluminium-canopy-tray-top](http://www.caddystorage.com.au/product-category/cab-chassis/aluminium-canopy-tray-top)



Scan QR code to view the page on our website



## FEATURES



### Internal Framework

All of our aluminium canopies are internally reinforced to ensure strength and longevity. The rib-like framework prevents your aluminium canopy from bending and warping. The same framework is applied to the side and rear doors.



### Customise your Fit out

Outfit your aluminium canopy with a multitude of products, including CPS Drawers (p. 30), Heavy Duty Drawers (p. 34), Mesh Partition (p. 48) and Aluminium Canopy Shelving (p. 12).



### Choose your body type

We have 3 great finishes to choose from: Flat Aluminium with a White powdercoat, Flat Aluminium with a Black powdercoat or Aluminium Propeller plate.

## ADDITIONS



### Trundle Drawer

This drawer makes use of the space underneath your ute tray. Available in 1800mm long or 2100mm long drawers. Secures levels, shovels, etc.



### Underbody box

Storage boxes with side openings. Can be positioned behind or in front of the rear wheels. Can be supplied with a white or propeller plate finish.



### Reverse system

We can fit rear sensors and/or cameras to your ute. This gives you as much awareness and safety as possible when reversing.



### Roof Rack System

2 or 3 bar roof racks available. Can be used to mount an assortment of other roof rack products on it. See Rhino-rack website for full details.



### Window + Guards

A window reinforced with a Mesh window guard. Can be placed on the rear of the Aluminium Canopy or behind the Cabin window.



### Remote Central Locking

We can install a Central Locking System to your Aluminium Canopy which can be operated through the vehicle's remote key activation.



### Lighting

Light up your work area with our LED internal strip lights. Low profile, cost effective and can output up to 340 lumen.



### Side Steps

U-shaped steel tube used as a step to access the roof rack area. Can be installed behind or in front of the rear wheels.



### Water Tank + Soap Dispenser

25 Litre underbody water tank with built in provisions for soap dispenser. Can be fitted on either side of the vehicle.



# CADDY TOOLBOXES

Similar to our Aluminium Canopies, Caddy Toolboxes serve as a cost-effective way to store and transport your tools and equipment.

Caddy Toolboxes are constructed from the same material as the aluminium canopies, however, the toolboxes feature a single in-built adjustable shelf as standard.

Toolboxes are a good product for those who don't need the full cover of an aluminium canopy and require more of an open air fit out for a bit more flexibility.

Most products available to the aluminium canopies can also be applied to Caddy toolboxes.

You can select from 3 different types of body finishes available: White powdercoat, Black powdercoat or Aluminium Propeller Plate.

For more information and to see our full range of available toolboxes please visit [www.caddystorage.com.au/product-category/cab-chassis/aluminium-tray-top-toolboxes](http://www.caddystorage.com.au/product-category/cab-chassis/aluminium-tray-top-toolboxes)



Scan QR code to view the page on our website



## FEATURES



### Single or Twin

You can choose between having a single or twin toolboxes installed onto your vehicle. We have three different sizes to offer: 1200mm, 1450mm and 1800mm long.



### Customise your Fit out

Outfit your Toolbox with a multitude of products, including CPS Drawers (p. 30), Flat Top Slides (p. 36) and Aluminium Canopy Shelving (p. 12).



### Choose your Toolbox type

We have 3 great finishes to choose from: Flat Aluminium with a White powdercoat, Flat Aluminium with a Black powdercoat or Aluminium Propeller plate.

## ADDITIONS



### Trundle Drawer

This drawer makes use of the space underneath your ute tray. Available in 1800mm long or 2100mm long drawers. Secures levels, shovels, etc.



### Underbody box

Storage boxes with side openings. Can be positioned behind or in front of the rear wheels. Can be supplied with a white or propeller plate finish.



### Reverse system

We can fit rear sensors and/or cameras to your ute. This gives you as much awareness and safety as possible when reversing.



### Roof Rack System

2 or 3 bar roof racks available. Can be used to mount an assortment of other roof rack products on it. See Rhino-rack website for full details.



### Ute Tray Drop Down Sides

In addition to installing the toolbox, we fit a short ute tray drop down side. We can also modify your existing tray to fit our toolboxes.



### Remote Central Locking

We can install a Central Locking System to your Aluminium toolbox which can be operated through the vehicle's remote key activation.



### Lighting

Light up your work area with our LED internal strip lights. Low profile, cost effective and can output up to 340 lumen.



### Side Steps

U-shaped steel tube used as a step to access the roof rack area. Can be installed behind or in front of the rear wheels.



### Water Tank + Soap Dispenser

25 Litre underbody water tank with built in provisions for soap dispenser. Can be fitted on either side of the vehicle.



# CADDY PARTS STORAGE (CPS) DRAWER

CPS Drawers are a handy toolbox drawer system used for small parts storage. It features an in-built handle and push button lock for ease of use. Our CPS Drawers are part of a modular system and are available in several different configurations to accompany your fit out.

## Specifications:

- All CPS Drawers are 450mm Deep and 495mm Wide
- Choose from five different heights: 1 high unit (155mm), 2 high unit (245mm), 3 high unit (345mm), 4 high unit (450mm), 5 high unit (545mm)
- Select from different configurations of carry case, standard small and standard large drawers
- Choose from a number of extras to enhance your drawer

For more information and to see our full range of small parts storage, visit [www.caddystorage.com.au/product-category/small-parts-drawers-plastics/cps-range](http://www.caddystorage.com.au/product-category/small-parts-drawers-plastics/cps-range)



Scan QR code to view the page on our website

## CONFIGURATIONS AVAILABLE



CPS Unit with all Carry Case Drawers. Used to hold CCA-1 Carry Cases. Good for organising small parts such as bolts, nuts, etc.



CPS Unit with all Standard Drawers. Can choose between small or large drawers. Can be used to hold tools or similar items.



CPS Unit with a combination of Carry case drawers and standard drawers. You can mix and match drawers to suit your style.

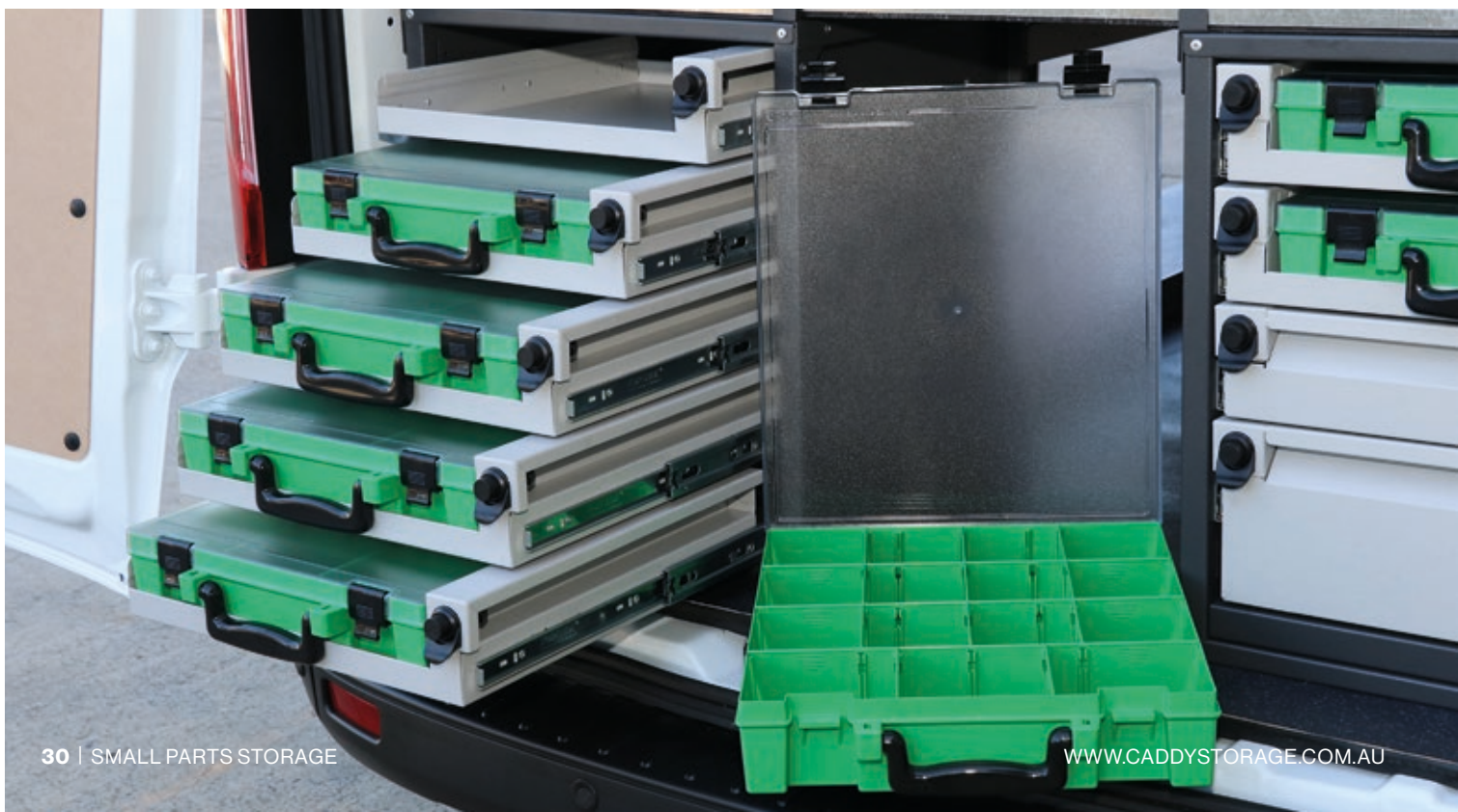

## ADDITIONS

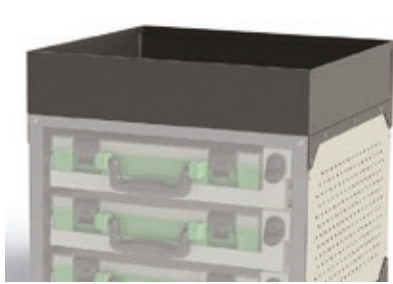

### Top Tray

Our most common addition to our CPS Drawers. We can install a tray on top of your CPS Drawer. Choose between 40, 80, 100 or 150mm high lips. Best used for storing items that require easy accessibility.



### Filing Cabinet Style Drawer

Transform your CPS Unit into a Filing Cabinet style Drawer with push key lock. Secures documents and other files. Only Available for 3, 4 or 5 high CPS Units. Suspension files sold separately.



### Side and Rear Cover Panels.

We can outfit your CPS drawer with side or rear cover panels. This stylish cover panel can be used to cover exposed areas of the CPS unit. Easy to install.

## OTHER STORAGE DRAWERS

### DSH STYLE DRAWER



An alternative design to standard drawers, servicing a similar purpose to a toolbox. Available in 5 different sizes, they feature lockable drawers and divides in each drawer for the ability to create separate compartments to organise your tools.

#### Optional Extras

- Top tray for extra storage space
- Base frame to suit application (custom sizes available)

### CPS BASE FRAME STORAGE BOX



A complimentary product to the CPS drawer, a CPS base frame can provide additional storage space. Can be installed with a lockable box. Compatible with all CPS Drawers. Maximises the efficiency of the CPS Drawer.

Only available with select vehicles.

## CASES AND LARGE BINS

### CC-1

100mm W x 175mm D x 85mm H

Carry Case with clear lid. Suitable for organising small components. Can hold up to 16 divisions with adjustable dividers.



### NALLY BIN

650mm W x 210mm D x 410mm H

Nally bin. Light, stackable and made from Polypropylene. Holds up to 32 Litres of storage. Perfect to place underneath a shelving unit.





CADDY



# PLASTIC BINS

Plastics bins can be used for any general small parts storage. Made from polypropylene plastic, which are highly resistant to physical impacts but also flexible enough to avoid shattering upon impact. Some key features include:

- Front handle with slot intended for labelling
- Colour code corresponding to the amount of capacity each bin can hold
- Divider slots and 2 free dividers, allowing for custom small part organisation (additional dividers sold separately)
- Bins are water resistant and can be washable with soap and water

Our plastics bins are typically used for our shelving units, but we can also recommend them for other storage purposes such as inventory storage for warehouses or supply room storage for hospitals. Lastly, we proudly source our plastic bins in Australia.

For more information and to see our full range of plastic bins visit [www.caddystorage.com.au/product-category/small-parts-drawers-plastics](http://www.caddystorage.com.au/product-category/small-parts-drawers-plastics)



## PBO 0.9

100mm W x 175mm D x 85mm H

0.9 Litre capacity stackable yellow polypropylene plastic storage bin with open front face to allow for easy access. Can be mounted on a Louvre panel.



## PBC 3.0

100mm W x 300mm D x 100mm H

3 Litre capacity yellow polypropylene plastic storage bin with 2 modular dividing slots. Closed design for secure storage. Suits Caddy Shelving.



## PBO 2.2

133mm W X 223mm D X 125mm H

2.2 Litre capacity stackable red polypropylene plastic storage bin with open front face to allow for easy access. Can be mounted on a Louvre panel.



## PBC 6.0

200mm W X 300mm D X 100mm H

6 Litre capacity red polypropylene plastic storage bin with 2 modular dividing slots. Closed design for secure storage. Suits Caddy Shelving.



## PBO 6.7

200mm W X 280mm D X 163mm H

6.7 Litre capacity stackable blue polypropylene plastic storage bin with open front face to allow for easy access. Can be mounted on a Louvre panel.



## PBC 4.0

100mm W X 400mm D X 100mm H

4 Litre capacity blue polypropylene plastic storage bin with 2 modular dividing slots. Closed design for secure storage. Suits Caddy Shelving.



## PBO 13.4

400mm W X 280mm D X 163mm H

13.4 Litre capacity stackable green polypropylene plastic storage bin with open front face to allow for easy access. Can be mounted on a Louvre panel.



## PBC 8.0

200mm W X 400mm D X 100mm H

8 Litre capacity green polypropylene plastic storage bin with 2 modular dividing slots. Closed design for secure storage. Suits Caddy Shelving.

# (DBD) HEAVY DUTY DRAWERS

The DBD Drawer is Caddy's signature drawer system. It has been designed and engineering to suit a wide range of trade applications and fit in all vehicles.

It has been engineered to ensure that it will stand up to the years of abuse in your trade vehicle.

Its modular size variations ensures that we will be able to provide you a drawer which suits your width, height, and depth you require.

For more information and to see our full range of Heavy Duty Drawers available visit [www.caddystorage.com.au/drawers/](http://www.caddystorage.com.au/drawers/)



Scan QR code to view the page on our website



## FEATURES



Our drawers are rated to support a 125KG distributed load.

We have performed cyclic testing to ensure that these drawers will not fail in the field. With the drawer running through 16000 in and out cycles without fail.



Our Lock handle has an ergonomic grip, with a large texturized rubber handle to ensure you are able to grip comfortably.

Each drawer lock comes keyed randomly from a set of our customised 5 Key combinations, this ensures your stored cargo is safe.



All drawers come with a standard lock in lock out function, this is a flush flip latch housed in the top cross bar of the outer casing.

This is to ensure when you are accessing your items, the drawer will not close on you.



We have incorporated adjustable lateral roller bearings into our new drawers.

These guides reduce possible friction between the inner and outer bodies. In turn creating a smooth motion going in and out.



We have specifically engineered our dual bearing wheels for this new drawer system to ensure they will last the test of time.



Available in single or double arrangements, standard or custom sizes depending on your vehicle.



# (DBT) HEAVY DUTY DRAWERS

The DBT Drawer is Caddy's newest innovation in storage. Our DBT Drawer has the unique feature of being about to opened from either end. This will allow you to conveniently access your tools, equipment and cargo from either the passenger or driver side of the vehicle.

It comes with all the standard features of the DBD Drawer.

The DBT drawer is perfect for Vans with Twin Sliding Doors or Aluminium Canopies.

For more information and to see our full range of Heavy Duty Drawers available visit [www.caddystorage.com.au/drawers/](http://www.caddystorage.com.au/drawers/)



The main feature of the Dual Bearing twin drawer is that it is Bi-directional and can be open from both the front and back face.



Scan QR code to view the page on our website

# FLAT TOP SLIDES

Caddy Slides are similar in structure to Caddy Drawer without top or side panels. Caddy Slides are made entirely of steel, maintaining the same load capacity as drawers - which also allows for the option of machinery or accessories to be mounted or welded directly to them.

Like Heavy Duty Drawers, they slide out to approximately 66% of their total length. When fully open, they lock into position to avoid roll-back.

Standard Caddy flat top slides can be used for multiple tasks as you find fit; secure your tools to it or use it as a bench top.

For more information and to see our full range of Flat top Slides available visit [caddystorage.com.au/product-category/drawers-and-slide-systems/](http://caddystorage.com.au/product-category/drawers-and-slide-systems/)



Scan QR code to  
view the page on  
our website



## FEATURES

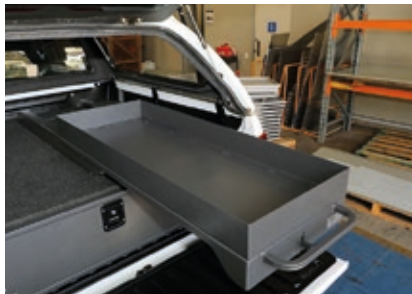

All drawers slide out approximately 66% of their original length and has a load rating of 100kgs.



Our Flat top design allows for a variety of products to be mounted on top.



Custom variations of our Caddy Slide design can be made to tailor to your specific type of work.



# (HDS) HEAVY DUTY SLIDES

This product is the latest iteration of our Slide Systems. We have designed and engineered a new slide which can support up to 170kg and can slide open to approximately 90% of its original length with a locking mechanism when fully open.

We offer an additional tie down kit which allows you to strap down products to your Heavy Duty Slide with ease.

## Features

- Heavy Duty Slide with Tray
- Load Rating: 170kg evenly distributed across the slide
- 2.5mm Steel construction powdercoated graphite ripple
- All Slide Systems slide out to 90% of overall length
- 30mm Handles attached to the front of the slide
- Lock-in and Lock Function (Lock Tabs must be pushed to close)
- 17mm Formply Base for easy screwing of accessories and equipment
- Additional Tie down kit available sold separately (PN: HDS-TIEDOWN-KIT)
- We offer a range of different Slide configurations and widths

For more information and to see our full range of Heavy duty Slides available visit [caddystorage.com.au/product-category/drawers-and-slide-systems/](http://caddystorage.com.au/product-category/drawers-and-slide-systems/)



Scan QR code to view the page on our website



HDS drawers slide out approximately 90% of their original length and has a load rating of 170kgs.



Redesigned grab handle feature along with a lock-in function. This ensures no movement when fully open.



HDS slides are compatible with most of our other Caddy Products including drawers, etc.

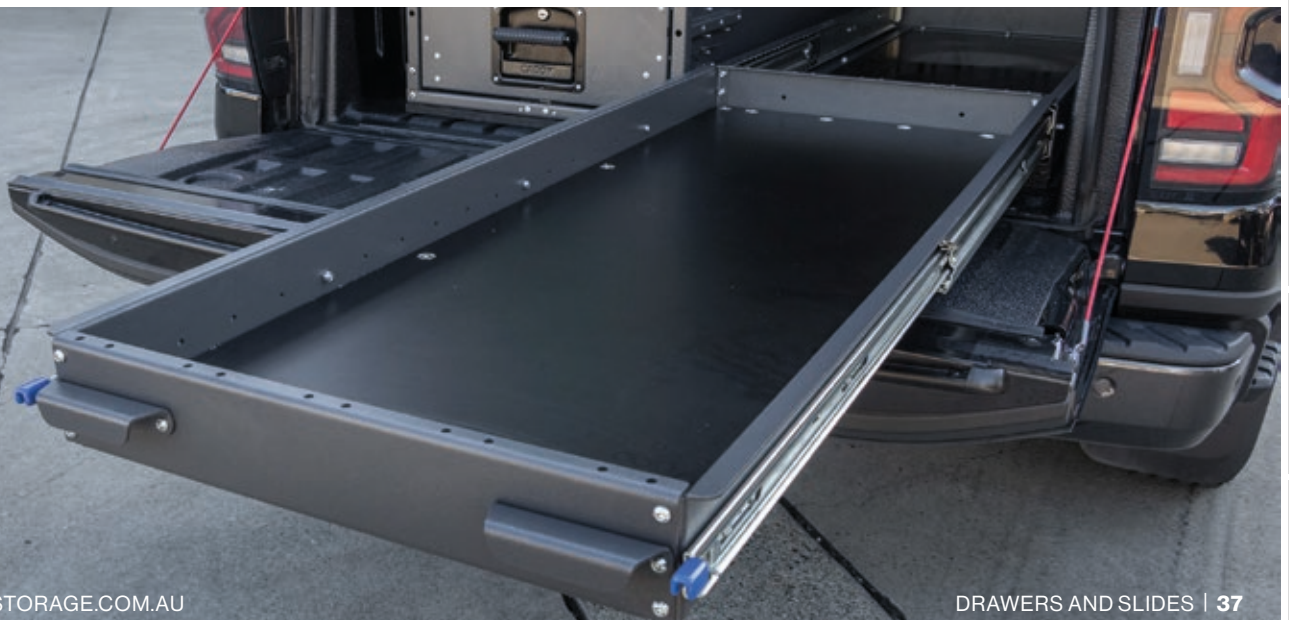

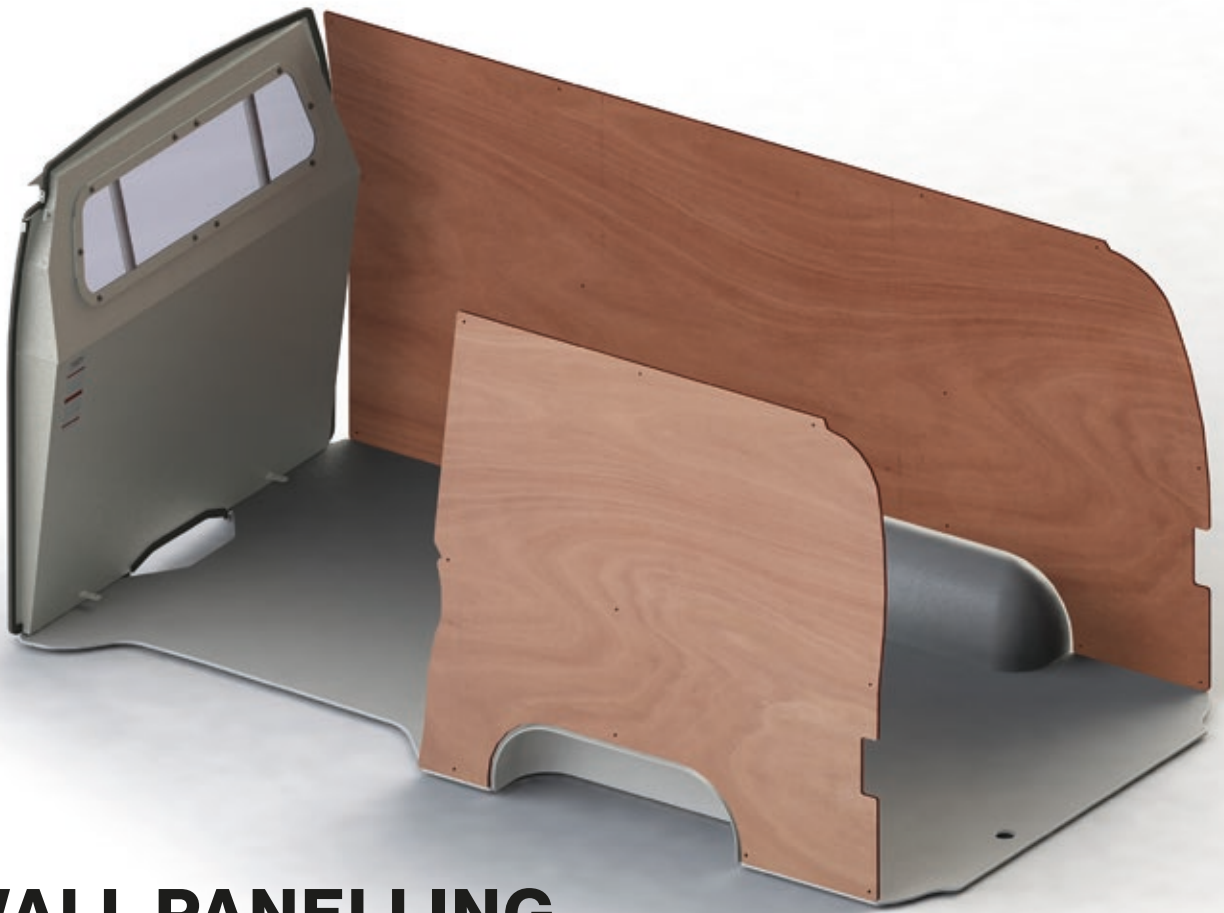

# WALL PANELLING

## Made to match any Van

Wall panelling can assist in safeguarding the internal shell of your vehicle. We cut common wall panels with our in-house CNC router to ensure they are all consistent with a profiled edge to suit your vehicle.

All options available in half height (fitted below the window panels) or full height (fitted to the top of the cantrail). Wall panelling can also be fitted to sliding and rear doors if required.

For more information and to see our full range of Wall Panelling available visit [www.caddystorage.com.au/product-category/vehicle-specific-accessories/wall-panelling](http://www.caddystorage.com.au/product-category/vehicle-specific-accessories/wall-panelling)



Scan QR code to  
view the page on  
our website

## OPTIONS AVAILABLE



### 9mm Plywood

Half and Full Height wall panelling options available

9mm thick plywood is cut using our CNC router. Wooden panels provide basic protection to your vehicle walls.



### 9mm Plywood and Carpet

Half and Full Height wall panelling options available

9mm thick plywood is cut via CNC machine. The pieces are then assembled and bonded with carpet top. Provides a soft surface and prevents scratching.

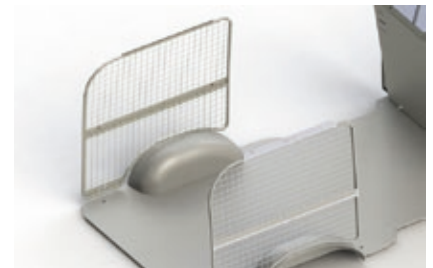

### Mesh Panel

We only offer this product to certain vehicles. Full Height only.

50mm x 50mm Mesh is welded to a steel frame shaped to match the vehicle interior. Panels are powder coated APO grey for a stylish look.

# FLOORING

**Made to match any vehicle floor.**

Flooring can assist in safeguarding the internal shell of your vehicle. We cut common floors with our in-house CNC router to ensure they are all consistent with a profiled edge to suit your vehicle. All options are profile cut to cover the entire cargo area. Rear and side metal trims supplied with floors where applicable.

For more information and to see our full range of flooring options, please visit [www.caddystorage.com.au/product-category/vehicle-specific-accessories/flooring](http://www.caddystorage.com.au/product-category/vehicle-specific-accessories/flooring)

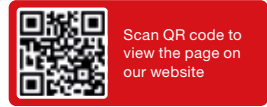
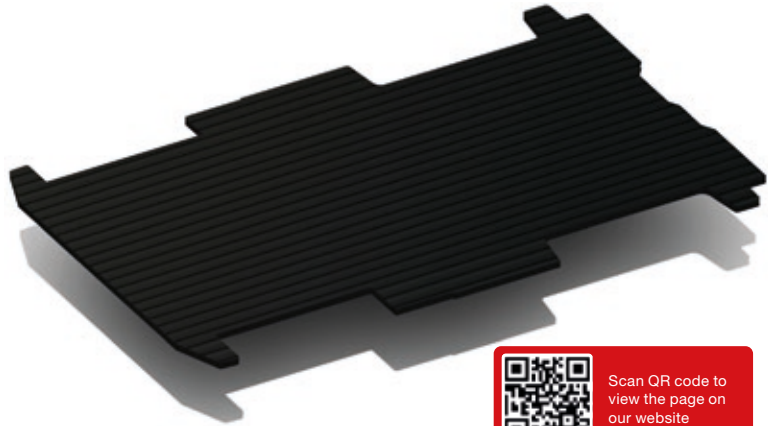

## FLOORING OPTIONS AVAILABLE

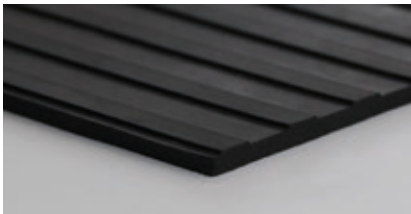

**5mm Rubber only**

We cut a vehicle profile from a single piece of 5mm ribbed rubber. The rubber is applied to the floor. Provides additional grip to the floor and prevents slip hazards.

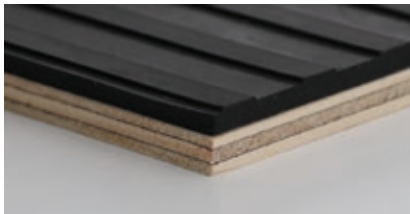

**9mm Plywood and 5mm Rubber**

9mm thick plywood cut into 3 or more shapes then bonded with 5mm Rubber top. Provides additional grip to the floor and prevents slip hazards.

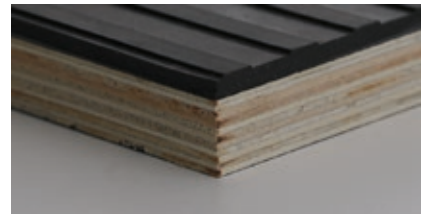

**17mm Formply and 5mm Rubber**

17mm thick formply cut into 3 or more shapes then bonded with 5mm Rubber top. Provides additional grip to the floor and prevents slip hazards.



**9mm Plywood**

Made from our warehouse, 9mm thick plywood is cut using our CNC router. Wooden panels provide basic protection to your vehicle floor.

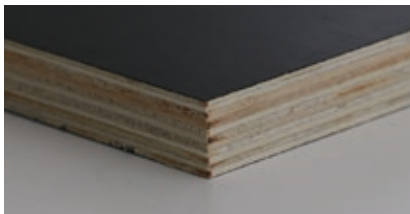

**17mm Formply**

Made from our warehouse, a 17mm thick formply is cut using our CNC machine. Formply panels provide even more protection than plywood.

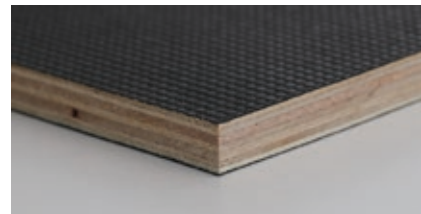

**Armourgrip**

Made from our warehouse, 12mm thick plywood with armourgrip coating is cut using our CNC machine. Prevents slip hazards.

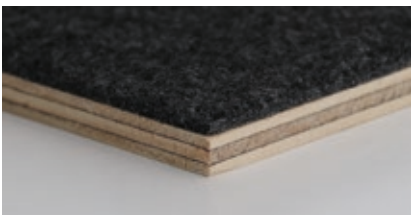

**9mm Plywood and Carpet**

9mm thick plywood cut into 3 or more shapes then bonded with 5mm Carpet top. Provides a soft surface for cargo to go on and prevents scratches.

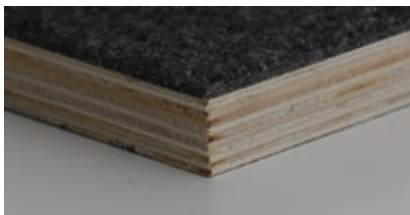

**17mm Formply and Carpet**

17mm thick formply cut into 3 or more shapes then bonded with 5mm Carpet top. Provides a soft surface for cargo to go on and prevents scratches.

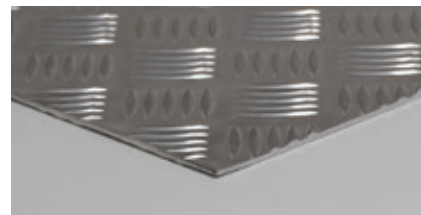

**Aluminium Checkerplate**

Made from our warehouse, a 2.5mm thick aluminium Checkerplate is cut using our laser machine. Metal panels provide reinforced protection.



## FALSE FLOORING

Having a false floor in your van or ute is an excellent way to manage your storage. This can be done by having a steel frame bolted to the vehicle which has a 17mm Timber floor attached (Height customisable). We also have an option to have rubber or carpet applied to the floor top. Also available to have a false floor on standard Caddy Drawers.

We offer a range of false floor systems for your needs that will be tailored to your work & your vehicle. This can combine one of our standard drawers in unison with a steel frame. Various height levels are available depending on the equipment you need to store.

For more information and to see our full range of False Flooring available visit [www.caddystorage.com.au/product-category/other-caddy-manufactured-items/false-flooring](http://www.caddystorage.com.au/product-category/other-caddy-manufactured-items/false-flooring)

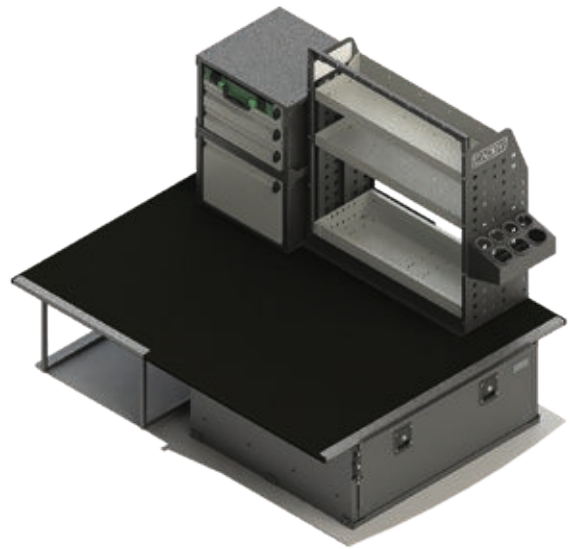

Scan QR code to  
view the page on  
our website









# WINDOW GUARDS

Manufactured locally, we can fit a set of mesh window guards for any vehicle. Painted Dark Grey for a Professional and clean look. We provide several different window guard options. Can be placed on various vehicle locations.

Window guards are an excellent addition to any kit, they prevent vehicle internal scratching normally caused by loose fitting cargo. They are also a visual deterrent for would-be thieves, adding an extra layer of security to your precious cargo.

For more information and to see our full range of window guards available visit [caddystorage.com.au/product-category/vehicle-specific-accessories/window-guards/](http://caddystorage.com.au/product-category/vehicle-specific-accessories/window-guards/)



Scan QR code to  
view the page on  
our website

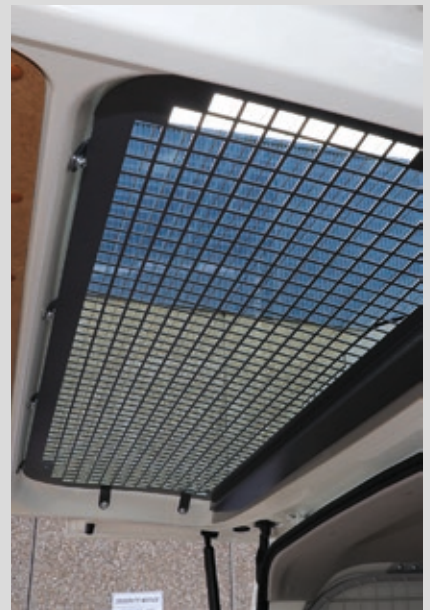
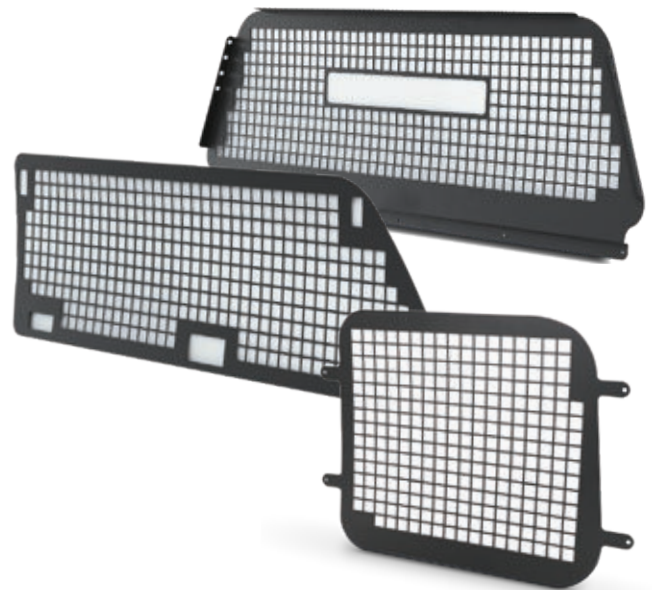



VEHICLE SHELVING

CARGO BARRIERS

REAR STEPS

UTE CANOPIES

ALLOY CANOPY / TOOLBOXES

SMALL PARTS STORAGE

DRAWERS AND SLIDES

WALL PANELLING / FLOORING

**WINDOW / WINDOW GUARDS**

OTHER ACCESSORIES

INDUSTRY SPECIFIC FIT OUTS

PARTNER / SUPPLIERS

# WINDOWS

We supply and install fixed and / or sliding windows.

Bonded fixed windows are available for both passenger and driver sides (depending on the vehicle) and suits most commercial vans.

Bonded sliding windows are available for both passenger and driver sides (depending on the vehicle) for better ventilation, suits most commercial vans.

For more information and to see our full range of windows available visit [www.caddystorage.com.au/product-category/vehicle-specific-accessories/windows](http://www.caddystorage.com.au/product-category/vehicle-specific-accessories/windows)



Scan QR code to view the page on our website



# AUTO ELECTRICAL

## LIGHTING

We supply a large range of internal and external lighting products. Whether it's lighting up your vehicle, lighting up your workspace or directing the flow of traffic. We have a set of lights for you.

For more information and to see our full range of lighting products available visit [www.caddystorage.com.au/product-category/electrical-equipment/lighting](http://www.caddystorage.com.au/product-category/electrical-equipment/lighting)



Scan QR code to view the page on our website



### LED LIGHTS

LED strip lights available for all vans and utes. Low profile and cost effective. Commonly used to light up your vehicle interior.



### WORK LIGHTS

Work lights available across all vans and utes. Can be installed inside the vehicle or on a roof rack. Good for on-site workers.



### FRONT SPOT LIGHT

We offer a range of front spot lights which can be mounted on top of the front protection bar or on the grill.



### ARROW BOARD SIGN

Tilting Arrow Board Sign with dashboard controls. Perfect for traffic control industries.



### WARNING LIGHTS

Rotating amber lights, LED mini bars and arrow bar lights available. Perfect for traffic control industries.



### FLASHING LIGHTS

Small amber LED lights available. Can be installed in either the front or the rear of the vehicle.

# AUTO ELECTRICAL

## ALARMS AND REVERSE PARKING ASSIST SYSTEMS

Driving accessories such as cameras and beepers ensure safety for people in close proximity to the vehicle when driving with limited visibility.

They can also assist in avoiding damage to the vehicle when parking or operating in confined spaces.

For more information and to see our full range of auto electrical products available visit [www.caddystorage.com.au/product-category/electrical-equipment](http://www.caddystorage.com.au/product-category/electrical-equipment)



Scan QR code to view the page on our website



### REVERSE CAMERA

Available for any vehicle. Includes camera and LCD screen or Rear View Mirror screen. Provides a clear view when reversing.



### SENSORS (NEW)

We supply new sensors which can be mounted onto our Caddy Storage Rear Steps.



### SENSORS (OEM)

We can take existing sensors from the vehicle and relocate it to our Caddy Storage Rear Steps.



### REVERSE BEEPER

Available for any vehicle, a reversing beeper emits a loud noise when the vehicle is in reverse.



Full LED warning light system. Best suited for Traffic Control Positions.



# AUTO ELECTRICAL

## POWER SUPPLY

Continue to work on-site with our power supply solutions. We order and install a variety of inverter systems, batteries, air compressor systems and plug and play sockets.

For more information and to see our full range of auto electrical products available visit [www.caddystorage.com.au/product-category/electrical-equipment](http://www.caddystorage.com.au/product-category/electrical-equipment)



Scan QR code to view the page on our website



### INVERTER SYSTEM

Pure sine wave output inverter. Used to power AC electronics.



### DUAL BATTERY SYSTEM

Complimentary item to Inverter. Powers inverter.



### 12V AIR COMPRESSOR SYSTEM

Portable system to power your air tools on-site.



### 12V ACCESSORY SOCKET

Plug and play sockets. 1 x Cigarette socket and 2 x USB-A type sockets.

# HEALTH AND SAFETY

## HYGIENE UNIT

Hygiene units are available with the backing panel, or the individual components can be obtained separately and bolted to various applications as they are required.

Full hygiene unit including tray, first aid kit, paper towel holder, fire extinguisher, soap dispenser and water container.

Additional products available include a sunscreen dispenser and mountable plastic bins.

For more information and to see our full range of hand wash solutions available visit [www.caddystorage.com.au/product-category/standard-shelving-kit-accessories/hand-wash-solutions](http://www.caddystorage.com.au/product-category/standard-shelving-kit-accessories/hand-wash-solutions)



Scan QR code to view the page on our website

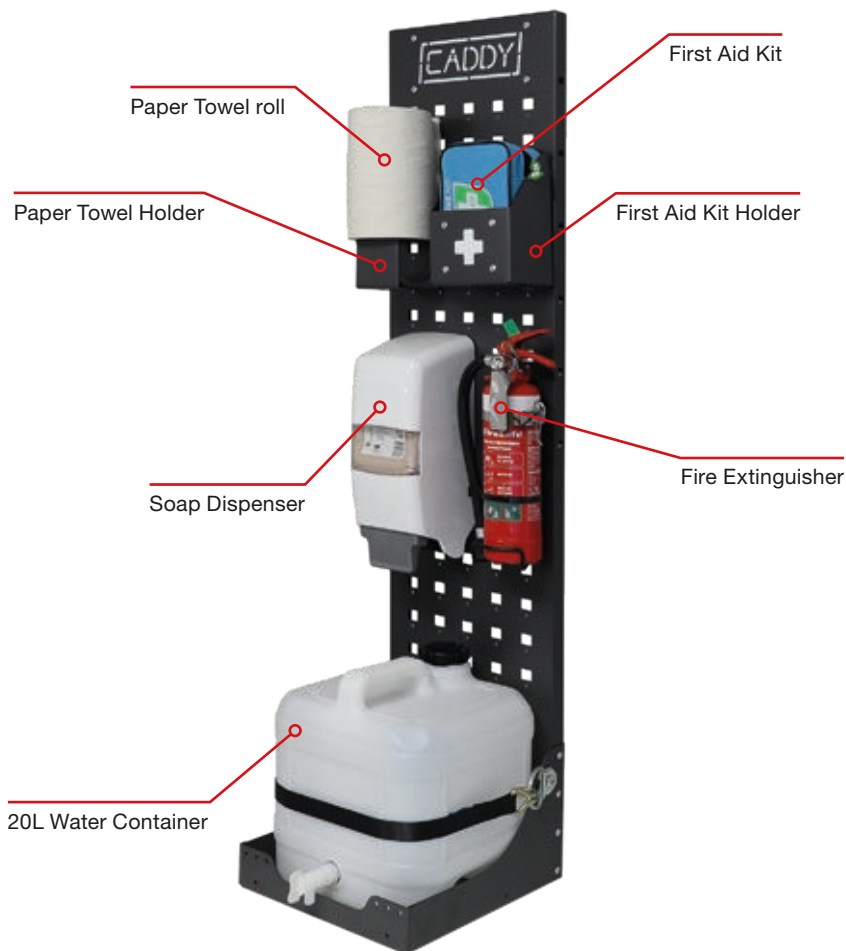

## FIRST AID KIT

First Aid Kits are an essential product for all trade industries. Small first aid kits (blue) cover minor injuries on the work site. Large first aid Kits (green) can cover all workplace related injuries on the work site.



Scan QR code to view the page on our website



## FIRE EXTINGUISHERS

We supply 1kg, 2kg, 4.5kg, 6kg and 9kg fire extinguishers. Mounting brackets included.



Scan QR code to view the page on our website





Scan QR code to  
view the page on  
our website

# TRADE ACCESSORIES



## MESH PARTITION

25mm x 50mm welded onto a steel frame and powder coated graphite grey. Ideal for segmenting different sections of the cargo area.

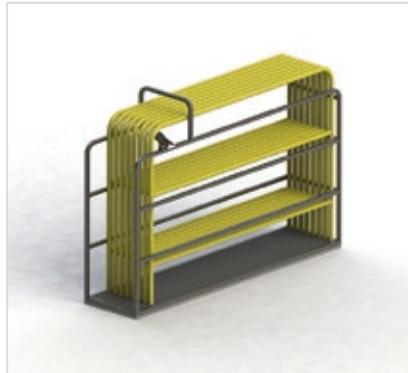

## GUARD FRAMES

Guard frames are used to store and transport manhole guards. Ideal for telecommunication jobs.



## INTERNAL LADDER SYSTEMS

To avoid Max Height Capacity in buildings, we can install a specialised space inside your vehicle to store a commercial ladder.



## JERRY CAN HOLDER

Stores standard 20 Litre Jerry Can. Good for transporting fuel or liquids safely.



## GAS BOTTLE BOX

Stores and encapsulates Oxy Acetylene Bottles, with a vent to safely dispense fumes. Good for transporting Gas Transportation.



## GAS BOTTLE FRAME

Stores Round LPG Bottles for easy access. Bottles are held in place using ratchet straps. Ideal for Air Conditioning Industries.





## ROLLER CABINET

Large Cabinet Shelf with a roller shutter door and magnetic locking. Keeps valuables safe. Ideally used for transporting electronics.



## ROOF VENT

Roof Vents allow the cargo area air to escape your vehicle while in transit. Can be fixed or rotary. Good for transporting gases.

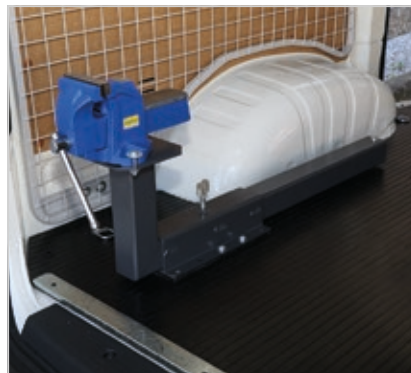

## VICE SLIDE & GRIP

Vice Grip with slide out arm. Various arm lengths and types available. Ideal for locksmiths.



## HAND WASH SYSTEM

Kinetics Hand washing system with Hot and cold taps. Good for washing hands on-site.



## WHEEL ARCH COVER

Covers and protects the wheel arches from damage. Ideal for couriers.



## WORKBENCHES

On-site workbench with removable table top. Good for on-site work. Ideal for locksmiths.



## CONSOLE BOX

Front centre console box to replace OEM centre consoles.



## GLASS RACK

Safely stores large glass panels for transporting. Carpeted Battens used to prevent damage.



## FIRE EXTINGUISHER RACK

Large storage rack to hold fire extinguishers. Good for Fire Protection Services.

# INDUSTRY SPECIFIC FIT OUTS

## TO SUIT MOST COMMERCIAL VEHICLES

Having a fit out tailor made to suit your field of work will help you to keep your tools and cargo well-organised for manageability and practicality. Each industry is different and requires its own type of storage system and accessories to make day-to-day work easier.

With dozens of configurations possible, choosing the perfect setup for you can be overwhelming, that is why we highly advise a visit to your nearest Caddy Storage outlet. Our team can discuss your priorities, assess your vehicle and recommend the most appropriate products and accessories to suit your application.

Here is a small sampling of some of the work we have produced over the years. To view our entire gallery of industry specific vehicle fit outs, visit [www.caddystorage.com.au/gallery](http://www.caddystorage.com.au/gallery)



Scan QR code to  
view the page on  
our website



Ask Instore



### ALL PURPOSE SOLUTION FOR VANS

To suit most commercial vans



Ask Instore



### ALL PURPOSE SOLUTION FOR UTES

To suit most commercial utes





## AIR CONDITIONING

To suit most commercial vans, utes and aluminium canopies



## ALARM TECHNICIANS

To suit most commercial vans



## ANIMAL TRANSFER

To suit most commercial vans, utes and aluminium canopies (with tray top)



## BUILDER / CONSTRUCTION

To suit most commercial vans

# INDUSTRY SPECIFIC FIT OUTS

TO SUIT MOST COMMERCIAL VEHICLES



PK1100



## COUNCIL (OUTDOOR WORK)

To suit most commercial vans,  
utes and aluminium canopies



AO0108



## COURIER / DELIVERY SERVICES

To suit most commercial vans



PK2894



## ELECTRICAL

To suit most commercial vans,  
utes and aluminium canopies



PK3440



## FIRE PROTECTION

To suit most commercial vans  
and utes



## FORKLIFT MAINTENANCE

To suit most commercial vans



## GENERAL SERVICES

To suit most commercial vans, utes and aluminium canopies



## HYDRAULIC AND HOSE CONNECTION

To suit most commercial vans



## HYGIENE

To suit most commercial vans



# INDUSTRY SPECIFIC FIT OUTS

TO SUIT MOST COMMERCIAL VEHICLES



MR0595



## IRONING SERVICES

To suit most commercial vans, utes and aluminium canopies



BA142



## LANDSCAPING / GARDENING

To suit most commercial vans, utes and aluminium canopies



ML2866



## LIFT MAINTENANCE

To suit most commercial vans and hatchback vehicles



PK2598



## LOCKSMITH

To suit most commercial vans, utes and aluminium canopies



RD8990



## MECHANICS

To suit most commercial vans, utes and aluminium canopies



RD7720



## MEDICAL / GAS TRANSFER

To suit most commercial vans and hatchbacks



MR/CW0384



## PEST CONTROL

To suit most commercial vans, utes and aluminium canopies



MR0958



## PHOTOGRAPHY / FILM

To suit most commercial vans

# INDUSTRY SPECIFIC FIT OUTS

## TO SUIT MOST COMMERCIAL VEHICLES



PK7244



### PLUMBER

To suit most commercial vans, and utes



RL/CW0043



### REAL ESTATE

To suit most commercial vans



GU160919



### SECURITY AND MONITORING SOLUTIONS

To suit most utes and aluminium canopies



SB6075



### SURVEYORS

To suit most commercial vans, utes and aluminium canopies







CW0374-2



## VALUABLE GOODS

To suit a wide range of hatchback and SUV vehicles



RD8281



## TELCO / FIBRE OPTICS

To suit most commercial vans



SB/PK1079



## TRAFFIC CONTROL

To suit most commercial vans, utes



PK2260



## GLASS / WINDSCREEN

To suit most commercial vans

**RHINO-RACK**

# ROOF RACK SYSTEMS

**LIFE IS BETTER WHEN WE MAKE SPACE FOR ADVENTURE**

Rhino-Rack has been creating world-class roof racks since 1992 and is one of Australia's most diverse and innovative range of roof rack products, supplying high-quality gear to all industry segments.

Rhino cater to the tradies. When you need reliable gear that works as hard as you do, look no further than their massive range of Heavy Duty roof racks, ladder racks, trays, conduits and more.

Rhino cater to the sun-seekers and nature lovers. Indulge your taste for adventure with a Rhino-Rack Foxwing awning, boat loader, luggage basket or fishing rod holders. Everything the Aussie camper needs for the ultimate getaway.

Most of all, they are there for the customer, to offer expert advice, help you choose the perfect roof rack product, and guide you on the best way to fit it to your vehicle.

At Caddy, we supply, order and install all Rhino-rack products (for both Trade and Lifestyle uses). To view our range of available Rhino Roof Racks and Accessories, visit [www.caddystorage.com.au/product-category/vehicle-specific-accessories/roof-racks](http://www.caddystorage.com.au/product-category/vehicle-specific-accessories/roof-racks)

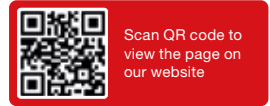

VEHICLE SHELVING

CARGO BARRIERS

REAR STEPS

UTE CANOPIES

ALLOY CANOPY / TOOLBOXES

SMALL PARTS STORAGE

DRAWERS AND SLIDES

WALL PANNELLING / FLOORING

WINDOW / WINDOW GUARDS

OTHER ACCESSORIES

INDUSTRY SPECIFIC FIT OUTS

PARTNER / SUPPLIERS

## GET READY FOR YOUR NEXT ADVENTURE!

Rhino-Rack believes there's an adventurer in all of us. It's what drives them to create world-ready outdoor gear, born and proven in Australia. Customers are their number one priority. Offering a premium product is also important to Rhino-Rack. Everything they sell is made and tested to strict Australian standards.

Rhino-Rack also works with car manufacturers to make sure they're completely on the ball with the latest vehicle trends. Here are some popular products they have to offer:



### Heavy Duty Roof Rack Bars

Rhino-Rack's Heavy Duty roof rack system is the tough and durable carrying solution for your work related gear. Perfect for tradesmen.



### Pioneer Platform

The Pioneer Platform is designed to be tough and allows you to load or unload your gear quickly and easily. Pioneer Tradie Trays with side rails provide added support.



### Vortex Roof Rack Bars

Rhino-Rack's Vortex roof rack system featuring the VGS strip is the perfect carrying solution for your leisurely activities.



### Alpha Canopy Roof Racks

Rhino-Rack has developed a set of roof racks designed specifically for Alpha Canopies. It is low profile, aesthetically pleasing and attaches to existing canopy tracks.



### Multi-slide Rack Systems

Whether you're an electrician, plumber, builder or a handyman - you'll need a ladder rack system to carry your extension ladder safely and securely.



### OH&S Ladders

OH&S Ladder feature a swivel-out rack for ease of use. It has also been designed in line with current Australian Work Health & Safety Regulations. Ideal for High Roof Vehicles.



**TRADESMAN**

# ROOF RACK SYSTEMS

**STRONG, FIT AND QUIET. IT'S NOT JUST FOR TRADIES.**

Roof racks that work just as hard on the weekend!

Tradesman Roof Racks manufacture roof racks for commercial, 4x4 and SUV vehicles. Each of the models (except the Flat-Deck and Trade-Max) are available in different styles:

- Basket (with all four side walls)
- Open ends (with side walls only)
- Flat-Deck (no walls).

The Oval Alloy and Oval Steel roof racks are available in a roof-top tent style which has three walls and a mesh floor at the front and space at the rear to place a roof-top tent.

Built to last, you will get full load rating on and off-road, and you can be sure that your rack will always be working for you, even when you don't feel like it! 100% full load rating on and off-road.

At Caddy we supply, order and install most available Tradesman Roof Racks for vans and utes. To see our range or available Tradesman Roof racks visit [www.caddystorage.com.au/product-category/vehicle-specific-accessories/roof-racks](http://www.caddystorage.com.au/product-category/vehicle-specific-accessories/roof-racks)



Scan QR code to view the page on our website



Trade-Max Roof Racks. Low Clearance



Oval Alloy Roof Racks



Commercial-Max Roof Racks





# VEHICLE SEATING

**5 YEAR WARRANTY. AVAILABLE ACROSS MOST COMMERCIAL VANS**

Techsafe are the trusted specialist supplier of passenger transport seating systems in an industry where safety and quality cannot be compromised. For over 40 years Techsafe have manufactured additional passenger seating for your van or minibus. With a market leading range of seating choices, caddy can supply and install Techsafe solutions that increase the seating capacity of your vehicle and compliment the existing interior.

Working with both in-house and independent technical engineers and testing houses to arrive at superior design solutions, all Techsafe seat products meet and exceed industry safety standards. Both dynamic crash testing and static pull testing is conducted to Australian design rules, ECE European

regulations and AS/NZS standards, ensuring compliance for all customers and industries, both here and abroad. Cutting edge production techniques and a streamlined efficient assembly process completes the cycle. All Techsafe products have a 5 year no fuss warranty.

To see our available range of seating see [www.caddystorage.com.au/product-category/generic-accessories/seating](http://www.caddystorage.com.au/product-category/generic-accessories/seating)



Two Seater Safety Excel Seats



Three Seater Safety Excel Seats



Front Centre Seat





# TOWBARS

## HAYMAN REESE - THEY KNOW TOWING.

Hayman Reese towbars are designed and engineered in Australia for Australian Vehicles. With over 70 years' experience, they know towbars better than anyone else.

All Hayman Reese towbars come with the following extras included as standard:

- + Limited Lifetime warranty
- + Tow ball and rated D shackles
- + MetalShield™, our unique two-stage surface protection
- + Vehicle specific plug-and-play trailer wiring - SmartClick™
- + Tested to Australian Standards AS/NZS4177 in a NATA accredited laboratory



At Caddy, we supply, order and install most available Hayman Reese Towbar Products. For our available range of Hayman Reese Towbars see [www.caddystorage.com.au/product-category/vehicle-specific-accessories/rear-protection-step-towbar](http://www.caddystorage.com.au/product-category/vehicle-specific-accessories/rear-protection-step-towbar)



Scan QR code to view the page on our website

## FEATURES



### TRUSTED NAME

A trusted brand in a niche market, Hayman Reese Towbars and Tow balls stands out above the rest.

### WARRANTY

All Hayman Reese Products have a limited lifetime guarantee. Contact Hayman Reese for more information.

### EXPANDING RANGE

Market leaders in research and development for towbars. Largest range of towbars for current vehicles.



## PROUD PARTNERSHIP WITH CADDY STORAGE

Caddy Storage is proud to announce that they have partnered nationally with towing equipment leaders Hayman Reese.

This allows Caddy Storage the opportunity to significantly increase their range of towing equipment designed for not only commercial vehicles, but also now for the passenger vehicle market.

This experience provides an unmatched level of trust, putting your mind at ease knowing that you and your family will be safe.

Caddy Storage will be able to fit your Hayman Reese product in one of our modern workshops across all Australian capitals, as well as offering the convenience of a mobile fitting service to come to your home or workplace. Caddy Storage will be carrying an extensive range of towbars for most popular makes and models.

In addition, Caddy Storage will also carry the following Hayman Reese equipment:

- Weight Distribution Bars
- Electric Brake controllers
- Towing accessories (shackles, tow balls, tongues, hitch pins, etc).

## AVAILABLE PRODUCTS



### HR TOWBARS

We supply, order and install most available Hayman Reese Towbars. Contact us in store.



### HITCH STEP

A Hayman Reese Product. Allows a quick, safe an easy access to rear of the vehicle.



### CADDY REAR STEPS

Hayman Reese Towbars are compatible with Caddy Storage Rear Steps. See Page 22 for more info.





ECB  
WORLD'S BEST  
WATER PUMP

ECB

ECB  
WORLD'S BEST  
WATER PUMP





# BULLBARS & NUDGE BARS

## AUSTRALIA'S OLDEST BULLBAR MANUFACTURER!

East Coast Bullbars have been the original manufacturers of Alloy Bullbars in Australia since 1971 and has built a reputation as Australia's leading Frontal Protection experts. Their Hi-Tensile alloy performs extremely well under stress to provide the best protection for you, your family, and your vehicle, that will never rust, and avoid corrosion. At Caddy, we supply, order and install most available ECB Products.

For our available range of ECB and Front Bars see [www.caddystorage.com.au/product-category/vehicle-specific-accessories/front-protection-bars](http://www.caddystorage.com.au/product-category/vehicle-specific-accessories/front-protection-bars)



## MAIN ADVANTAGES OF ECB PRODUCTS

- Exclusive Lifetime Warranty
- ADR Compliant & Air-bag Compatible
- Australian Made
- Hi-Tensile Alloy with Industry Leading Material Thickness
- Specifically Engineered 8mm Steel Mounts
- LED Indicator/Park lights / DRL's
- Premium Range of Finishes
- Won't affect New Vehicle Warranty
- Over 50 years' experience in the Industry



Scan QR code to view the page on our website



Front Bars available for SUVs and Utes



Front Bars available for Vans



Front Bars available for 4WDs





# VISIT A CADDY SHOWROOM TODAY!

Each of our stores have their own full equipped showrooms and fitting stations on the premises. All showrooms are open for viewing anytime during business hours; 7am - 5pm Monday to Thursday, 7am - 4pm Friday.

Come in and view our realistic showroom displays for a hands-on experience with our products.



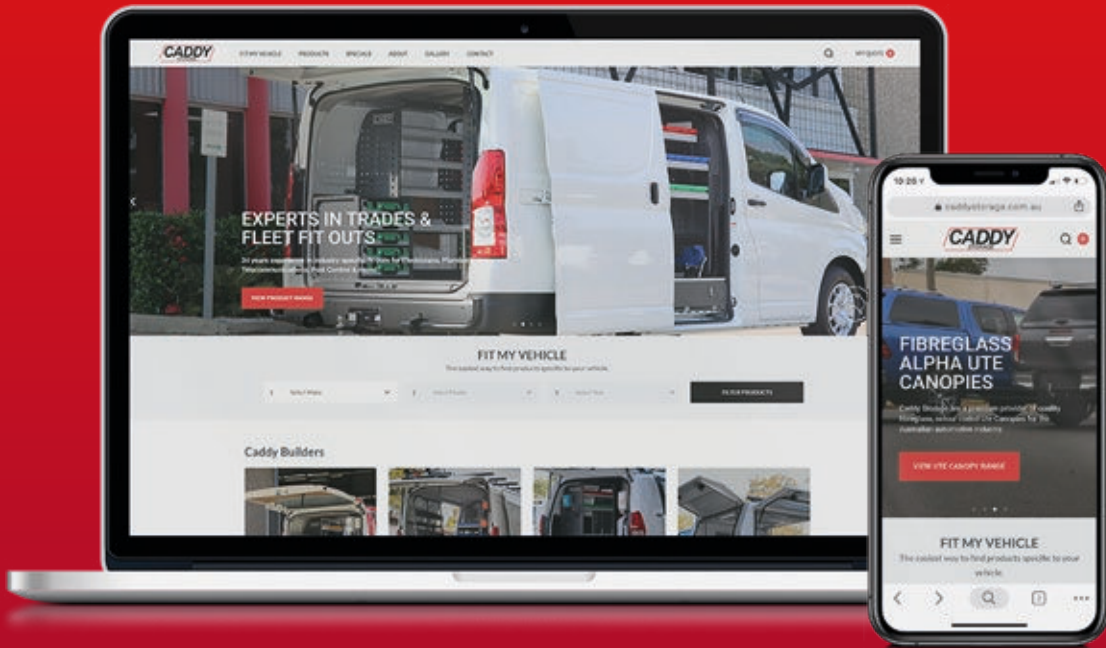

# FIND MORE INFORMATION ONLINE

Visit [www.caddystorage.com.au](http://www.caddystorage.com.au) for more information on our products, the latest special offers and any other developments from our company. We have plenty of resources including a step-by-step builder for certain products and vehicles.

To begin fitting your vehicle go to [www.caddystorage.com.au/fit-my-vehicle](http://www.caddystorage.com.au/fit-my-vehicle) or scan the QR code:



Scan QR code to  
Fit my Vehicle



All you need in one place. For all your vehicle storage solutions!

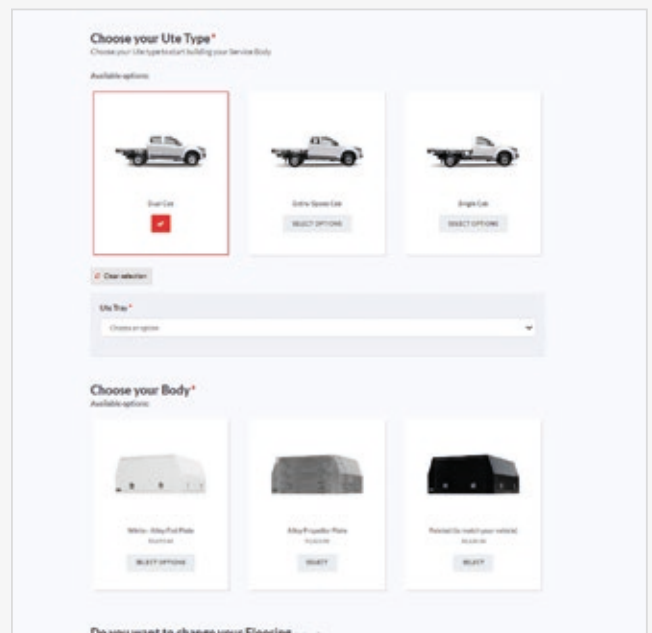

Use our in-built builder to craft the fit-out you want.

# CONTACT US

14 LOCATIONS AVAILABLE NATIONWIDE

## CADDY MAIN BRANCHES

### CADDY STORAGE BLACKTOWN

4-8 Gate Road Blacktown, NSW 2148  
(02) 9831 2878  
info@caddystorage.com.au

### CADDY STORAGE TUGGERAH

4 Hereford Street Berkley Vale, NSW 2261  
(02) 4302 0618  
tuggerah@caddystorage.com.au

### CADDY STORAGE PRESTONS

7/16 Bernera Road Prestons, NSW 2170  
(02) 9221 6362  
prestons@caddystorage.com.au

### CADDY STORAGE BERESFIELD

1/14C Cobbans Close Beresfield, NSW 2322  
(02) 4072 2111  
beresfield@caddystorage.com.au

### CADDY EQUIPMENT QUEENSLAND

49 Corymbia Place Parkinson, QLD 4115  
(07) 3800 9222  
brisbane@caddystorage.com.au

### CADDY STORAGE BRENDALE

2-4 French Avenue Brendale, QLD 4500  
(07) 3448 0301  
brendale@caddystorage.com.au

### CADDY STORAGE BURLEIGH HEADS

4/38 Township Drive Burleigh Heads, QLD 4420  
(07) 5681 8087  
burleigh@caddystorage.com.au

### CADDY STORAGE LAVERTON NORTH

7 Norwest Avenue Laverton North, VIC 3026  
(03) 9369 9799  
melbourne@caddystorage.com.au

### CADDY STORAGE BRAESIDE

24 Graham Daff Boulevard Braeside, VIC 3195  
(03) 9580 3058  
melbourne.east@caddystorage.com.au

### CADDY STORAGE PERTH

57 Mordaunt Circuit Canning Vale, WA 6155  
(08) 9256 3309  
wa@caddystorage.com.au

## CADDY AFFILIATED STORES

### CADDY ADELAIDE

163 Main North Road Nailsworth, SA 5083  
(08) 7109 0980  
sales@caddyadelaide.com.au

### CADDY TAREN POINT

148 Taren Point Road Taren Point, NSW 2229  
(02) 9540 2622  
tarenpoint@caddystorage.com.au

### CADDY WOLLONGONG

Unit 12, 16/18 Waynote Place Unanderra, NSW 2526  
(02) 4216 6006  
bblain@caddyadelaide.com.au

### CADDY BY LIFESTYLE (NORTH PARRAMATTA)

8/2 Windsor Rd Northmead, NSW 2151  
(02) 8855 6500  
sales@lifestylestore.com.au

Our ambition is to provide a well-organised, manageable and practical storage solutions and accessories for any vehicle in any trade. No business is too big or too small - we cater to anyone, from sole trades to national fleet companies in industries such as:

- Electrical
- Plumbing
- Locksmiths
- Air Conditioning
- Telecommunications
- Water Services
- General Maintenance
- Transport
- Traffic Control
- Materials Handling
- Pest Control
- Fleet Solutions

.. and many more!

The information in this catalogue has been presented in good faith and we have endeavoured to provide true and current specification which we believe to be correct at the time of print. Caddy Storage, or any of its affiliates, accepts no responsibility for mistakes or print errors that may have occurred. Please contact our Head Office if you have queries relating to the information in this catalogue. No part of this catalogue may be reproduced with the expressed written permission of Caddy Storage.

